

Knöpfe/

knobs



Griffe/

handles



Möbelfüße/

furniture legs

Profile/

profiles

Art.Nr./

item no

Lochabstand/drilling distance

32mm

32

64mm

64

96mm

96

128mm

128

160mm

160

länger/longer

L



Laminäre

8225/180 | GL35 MT106

8225

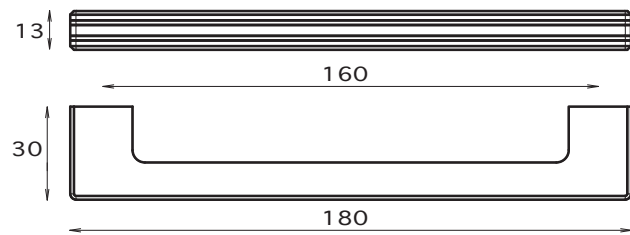

160

(insert M4)

Art.Nr. item no	mm	Lochabstand drilling distance	Farbe colour
8225	180	160	unbegrenzte Farbvielfalt endless colour combination

2



8225/180 | CP195M MT1



8225/180 | GL35 MT106



8225/180 | GL36 AC1



8225/180 | A126



8225/180 | CP195M MT1



8225/180 | A126

Laminäre

8225

160

3

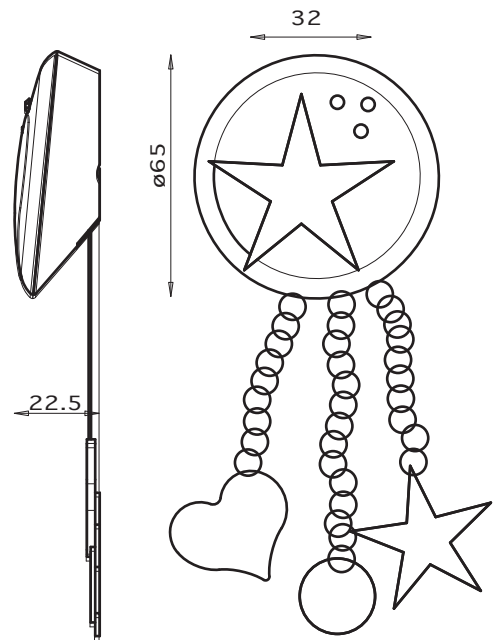

Art.Nr. item no	mm	Lochabstand drilling distance	Farbe colour
8226	65	32	unbegrenzte Farbvielfalt endless colour combination



8226/65 Sweety2



8226/65 Sweety2



Key Hole

8229

64

96

128

160

L



8229/500 MF13 DE



8229/500 MF2 DE



8229/500 HF60 HG DE



8229/500 MF2 DE

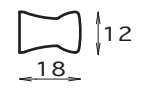
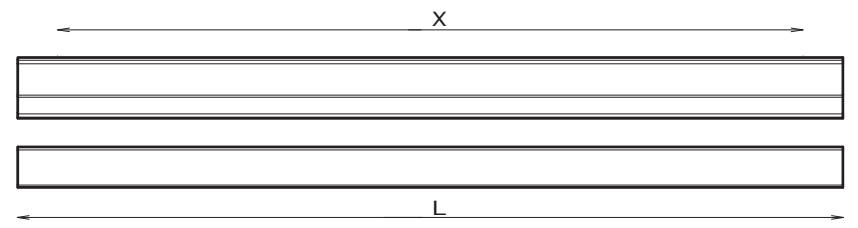

Art.Nr. item no	mm mm	Lochabstand drilling distance	Farbe colour
8229	100	64	unbegrenzte Farbvielfalt endless colour combination
	166	128	
	200	160	
	350	160x2	
	500	160x3	
	500	160x3	
(L) Length/ (x) Drilling Distance			Upon Request



Key Hole

8229

64

96

128

160

L



8229/500 MF2 DE



8231
8233

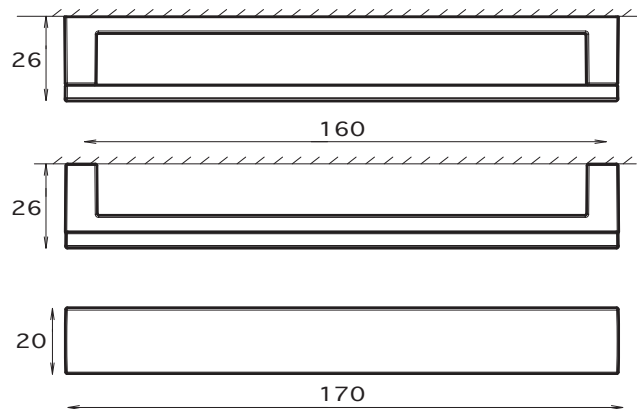

160

Art.Nr. item no	mm	Lochabstand drilling distance	Farbe colour
8231 8233	170	160	unbegrenzte Farbvielfalt endless colour combination



8231/170 MV11 MV11

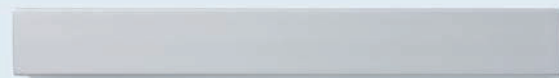

8231/170 GL36 GL36



8233/170 CP195G MV2



8231
8233

160

8231/170 T7 MV2

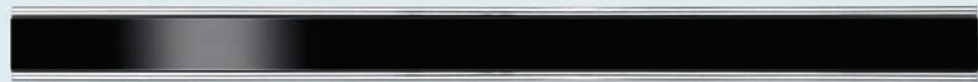

8232/200 MF2 DE CF5



8232/200 CF1 DE HF63



8232/200 MF2 DE CF5

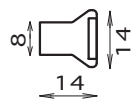
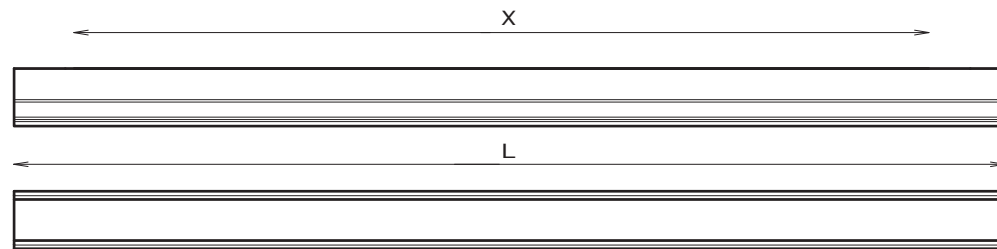

Art.Nr. item no	mm mm	Lochabstand drilling distance	Farbe colour	
8232	100	64	unbegrenzte Farbvielfalt endless colour combination	
	166	128		
	200	160		
	350	160x2		
	L	500		160x3
		(L) Length/ (x) Drilling Distance		Upon Request



8232/180 CF1 DE HF63



IKARUS Bar

8234

64

96

128

160

L

12

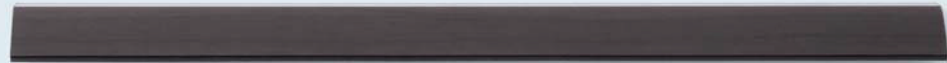

8234/200 HF60 DE



8234/200 MF2 DE



8234/200 HF60 DE

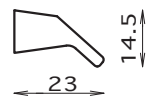
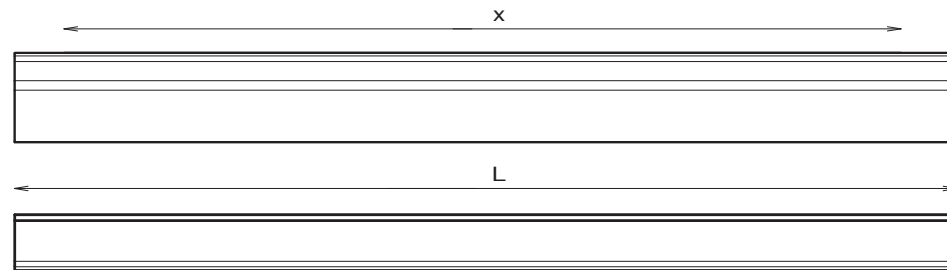

Art.Nr. item no	mm mm	Lochabstand drilling distance	Farbe colour
8234	100	64	unbegrenzte Farbvielfalt endless colour combination
	166	128	
	200	160	
	350	160x2	
	500	160x3	

(L) Length/ (x) Drilling Distance

Upon Request



8234/200 MF18 DE



IKARUS Bar

8234

64

96

128

160

L

13

Slim-line

8235

64
96
128
160
L



8235/500 MF2 DE



8235/180 MF2 DE



MF2 DE



HF15 DE



HF16 DE



HF60 DE



HF65 DE

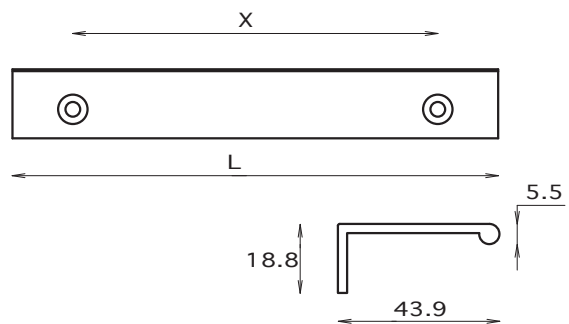
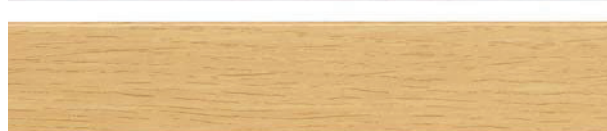

Art.Nr. item no	mm mm	Lochabstand drilling distance	Farbe colour
8235	180 500	128 320	unbegrenzte Farbvielfalt endless colour combination
(L) Length/ (x) Drilling Distance			Upon Request



8235/500 MF2 DE

Slim-line

8235

64
96
128
160
L



8236/166 MF13 DE



8236/166 CF5 DE

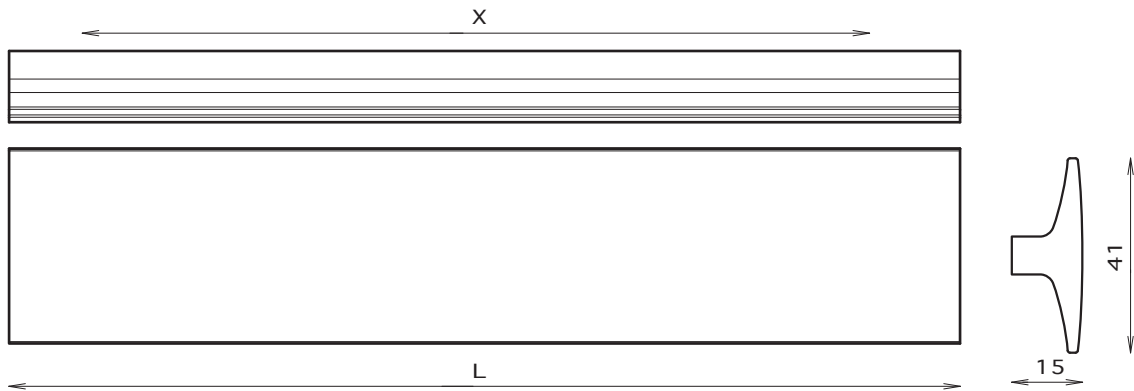

Art.Nr. item no	mm mm	Lochabstand drilling distance	Farbe colour
8236	100	64	unbegrenzte Farbvielfalt endless colour combination
	166	128	
	200	160	
	350	160x2	
	500	160x3	

(L) Length/ (x) Drilling Distance

Upon Request



8236/166 MF13 DE



Wing Bar

8237

- 64
- 96
- 128
- 160
- L



8237/200 MF13 DE

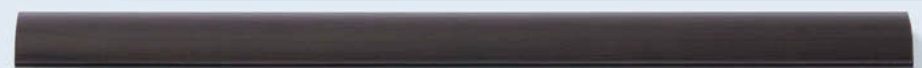

8237/200 HF60 DE

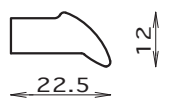
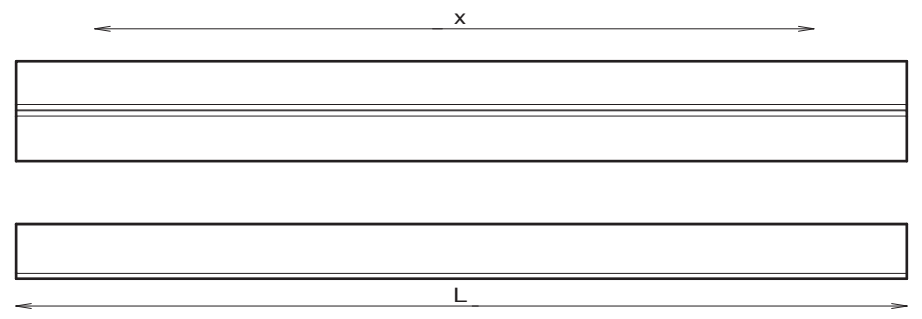

Art.Nr. item no	mm mm	Lochabstand drilling distance	Farbe colour
8237	100	64	unbegrenzte Farbvielfalt endless colour combination
	166	128	
	200	160	
	350	160x2	
	500	160x3	
	L		
(L) Length/ (x) Drilling Distance			Upon Request



Wing Bar

8237

- 64
- 96
- 128
- 160
- L

8237/200 CF1 DE



8238/200 CF1 DE MF2



8240/200 MF42 DE MF2

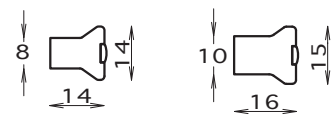
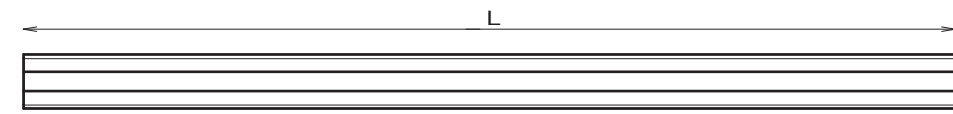
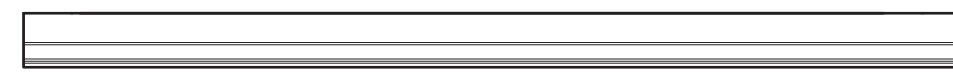

8238

8240

Art.Nr. item no	mm mm	Lochabstand drilling distance	Farbe colour
8238	100	64	unbegrenzte Farbvielfalt endless colour combination
8240	166	128	
	200	160	
	350	160x2	
	500	160x3	
	500	160x3	
(L) Length/ (x) Drilling Distance			Upon Request



8240/350 MF42 DE MF2



8239/190 MV2 MF12



8239/190 MT114 MV114



8239/190 MT1 MF42



8239/190 MT1 HF60

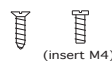
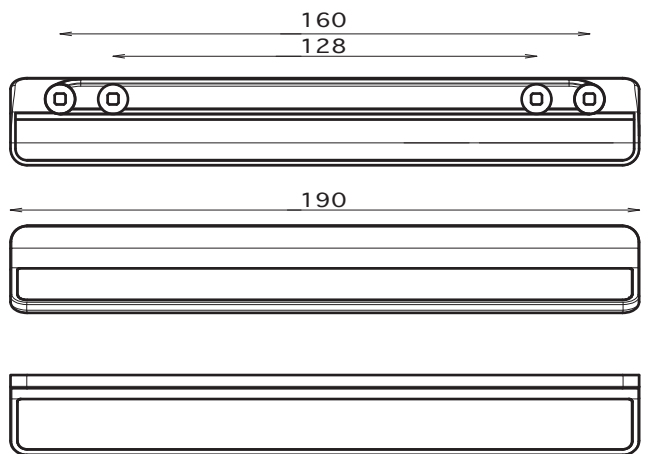

(insert M4)

Art.Nr. item no	mm mm	Lochabstand drilling distance	Farbe colour
8239	190	128 160	unbegrenzte Farbvielfalt endless colour combination



8239/190 MV2 MF12



Winflot

8241

128

24



8241/206 MV2

8241/206 GL35

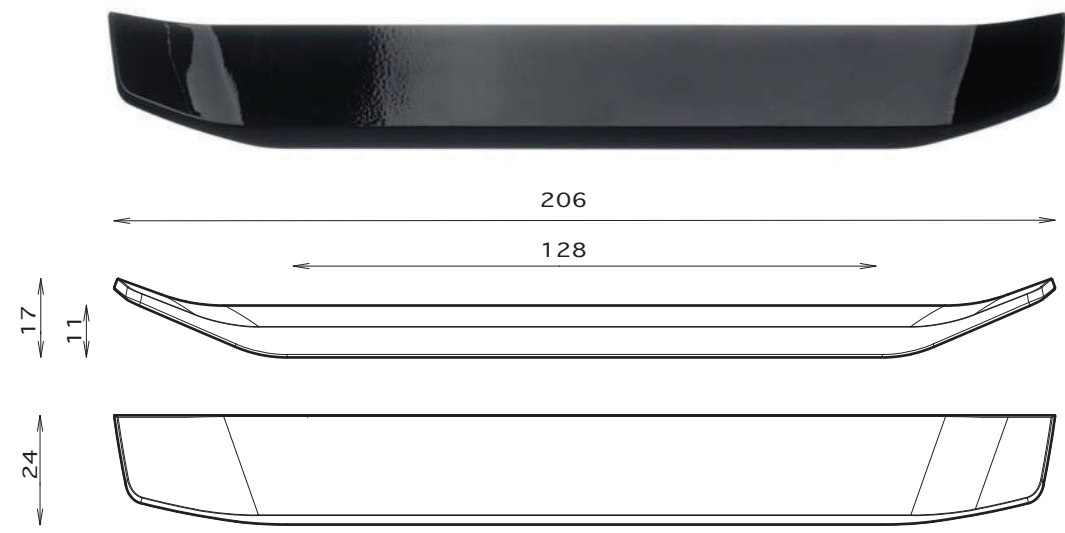

Art.Nr. item no	mm mm	Lochabstand drilling distance	Farbe colour
8241	206	128	unbegrenzte Farbvielfalt endless colour combination



Winflot

8241

128

25

8241/206 MV2



8072/25 MV2



8072/25-2 MV2



8242/41 GL35



8242/41 MT1



8242/169 GL35



8242/169 MT1

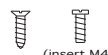
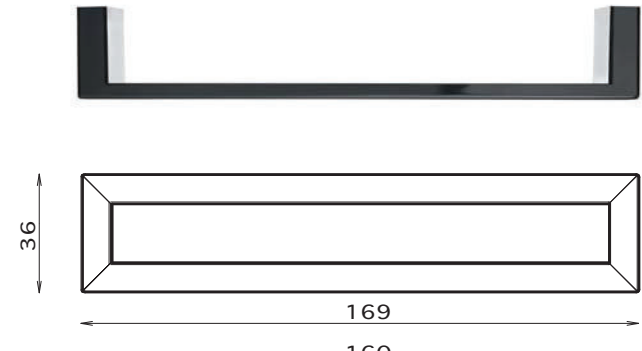
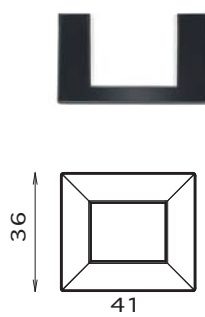
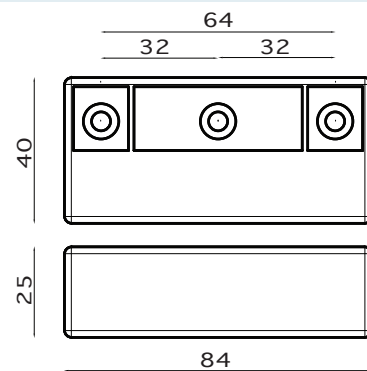

(insert M4)

Art.Nr. item no	mm mm	Lochabstand drilling distance	Farbe colour
8072	84	64	unbegrenzte Farbvielfalt endless colour combination
8242	41/169	32 / 160	



8242/169 MT1

8072/25 MT1



Stealth

8243

128

28



8243/170 GL36



8243/170 GL35

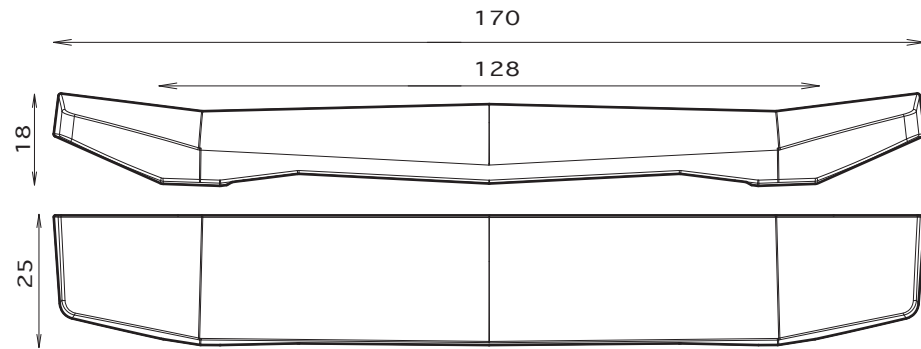

Art.Nr. item no	mm mm	Lochabstand drilling distance	Farbe colour
8243	170	128	unbegrenzte Farbvielfalt endless colour combination



Stealth

8243

128

29

8243/170 GL35



8244/200 K1 TM2 HG



8244/200 SK255 TM6 HG

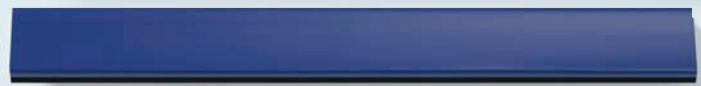

8244/200 K1 TM4 HG



8244/350 K1 TM4 HG



mm

Art.Nr. item no	mm mm	Lochabstand drilling distance	Farbe colour
8244	100	64	unbegrenzte Farbvielfalt endless colour combination
	166	128	
	200	160	
	350	160x2	
	500	160x3	

(L) Length/ (x) Drilling Distance

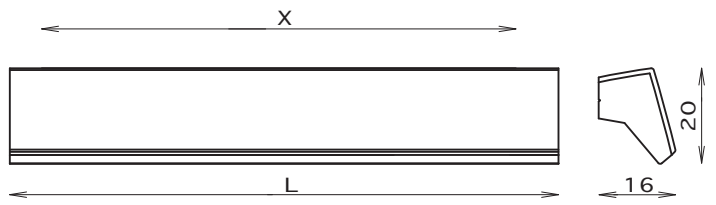

8244/200 SK255 TM6 HG



Canbus_2

8245

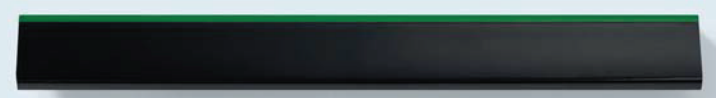

8245/200 K1 TM2 HG

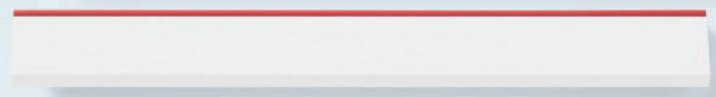

8245/200 SK255 TM6 HG



8245/200 K1 TM4 HG

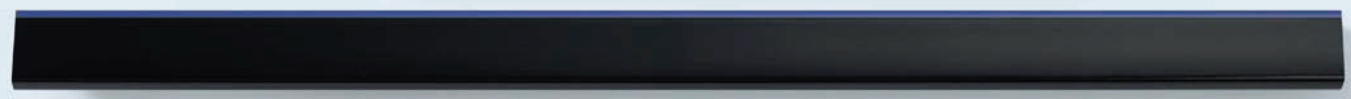

8245/500 K1 TM4 HG



64

96

128

160

L

32



Art.Nr. item no	mm mm	Lochabstand drilling distance	Farbe colour
8245	100	64	unbegrenzte Farbvielfalt endless colour combination
	166	128	
	200	160	
	350	160x2	
	500	160x3	
	(L) Length/ (x) Drilling Distance		

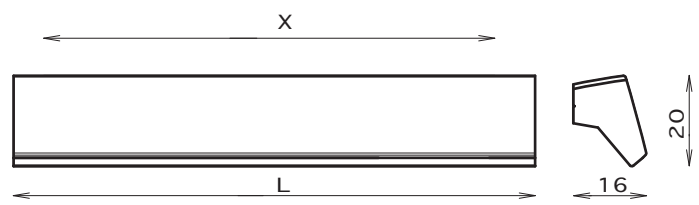

Canbus_2

8245

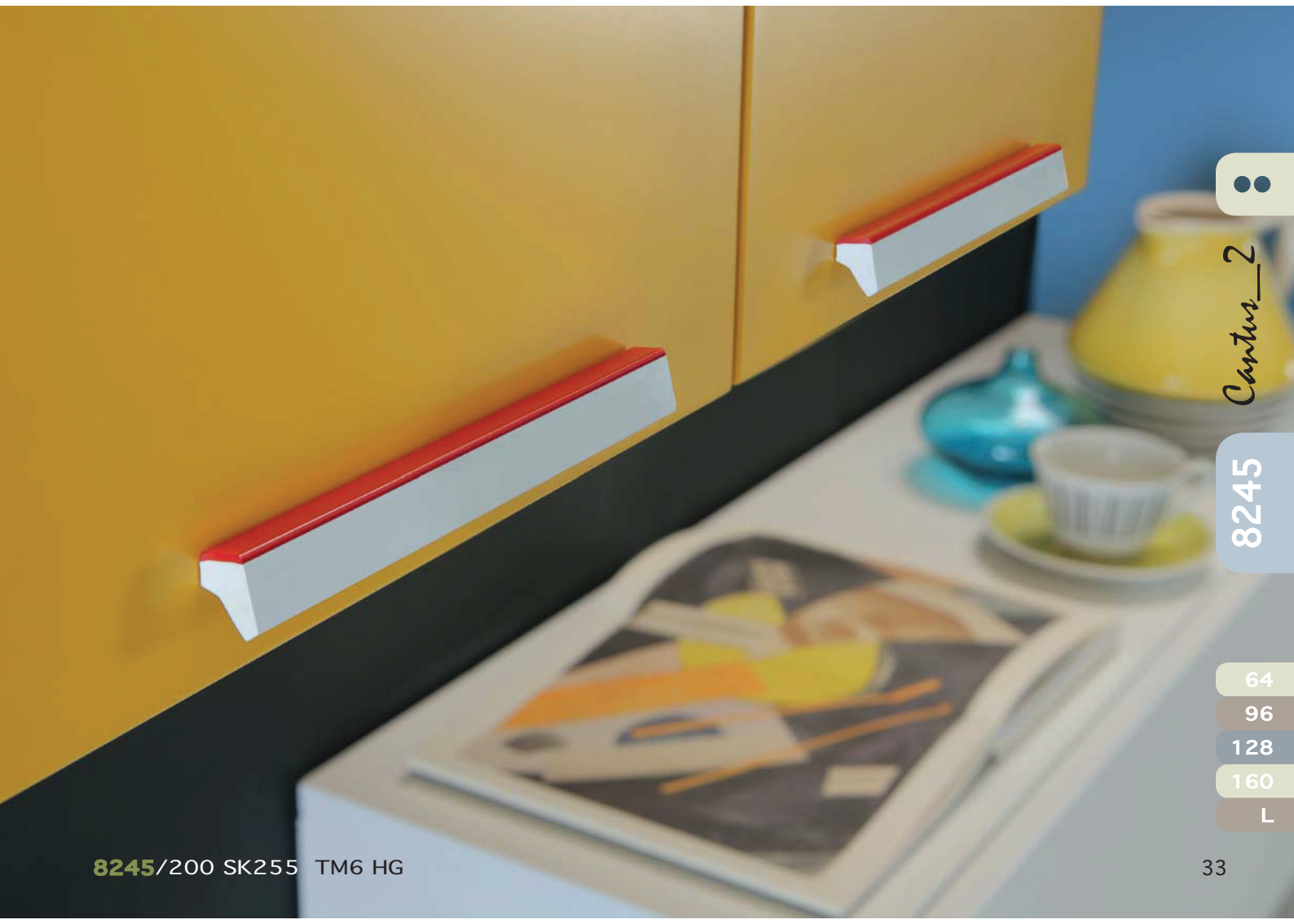

8245/200 SK255 TM6 HG

64

96

128

160

L

33



(insert M4)

Art.Nr. item no	mmv mm	Lochabstand drilling distance	Farbe colour
8246	200	128	unbegrenzte Farbvielfalt endless colour combination

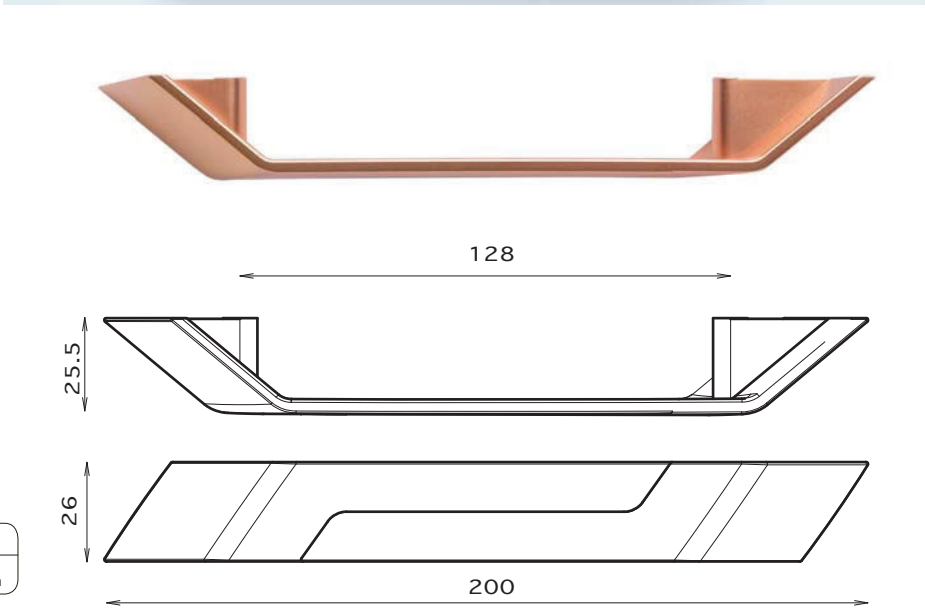



8247/164 K1 CF1



8247/164 SK602 CF3



8247/164 K1 MF13 MF13

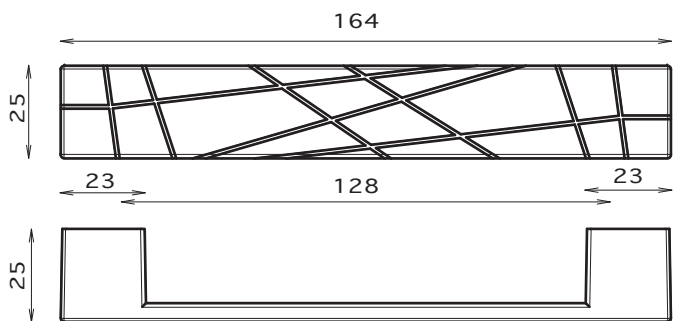

Art.Nr. item no	mm mm	Lochabstand drilling distance	Farbe colour
8247	164	128	unbegrenzte Farbvielfalt endless colour combination

8247

128

36



8247/164 K1 MF13 MF13

8247

128

37

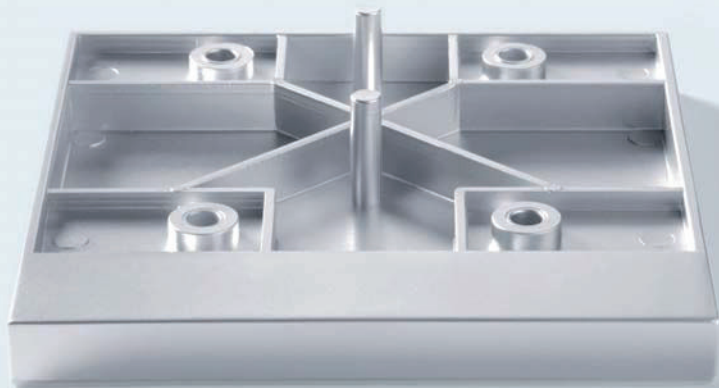

8248/96 MV2

8248/96 MV104

8248/96 MV114

8248/96 MV116

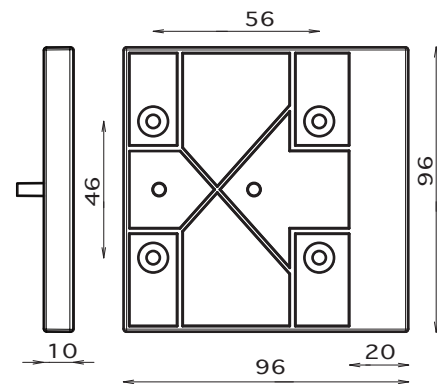

Art.Nr. item no	mm mm	Lochabstand drilling distance	Farbe colour
8248	96	46/56	unbegrenzte Farbvielfalt endless colour combination

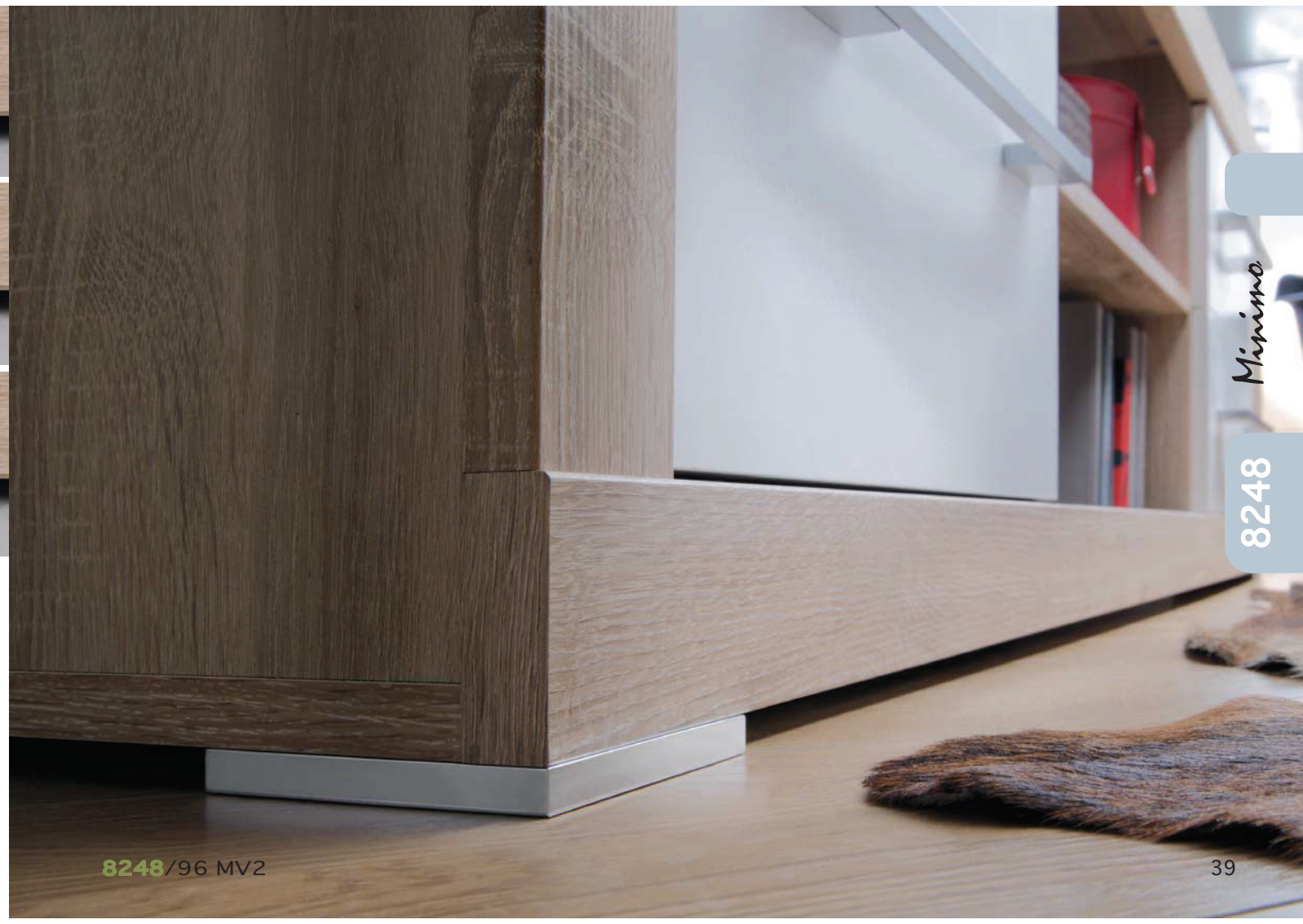

8248/96 MV2



8249/40I LS9 GL36



8249/40I LS8 CP125G



8249/40I LS7 MV2



8249/40I LS8 GL36

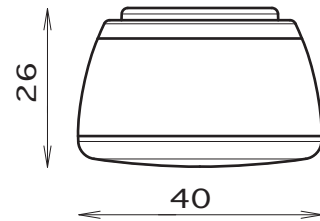

Art.Nr. item no	mm mm	Lochabstand drilling distance	Farbe colour
8249	40	-	unbegrenzte Farbvielfalt endless colour combination



8249/40I LS9 GL36



8250/500 HF16 DE



8250/500 CF1 DE



8250/200 HF52 DE

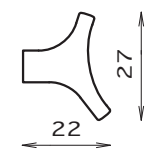
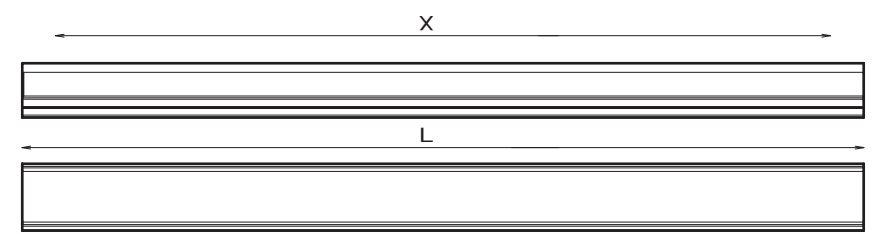

Art.Nr. item no	mm mm	Lochabstand drilling distance	Farbe colour
8250	100	64	unbegrenzte Farbvielfalt endless colour combination
	166	128	
	200	160	
	350	160x2	
	500	160x3	

(L) Length/ (x) Drilling Distance



8250/350 CF5 DE



8198/44I K1 AC1



8198/44I K10 AC1



8198/40I CP195 M

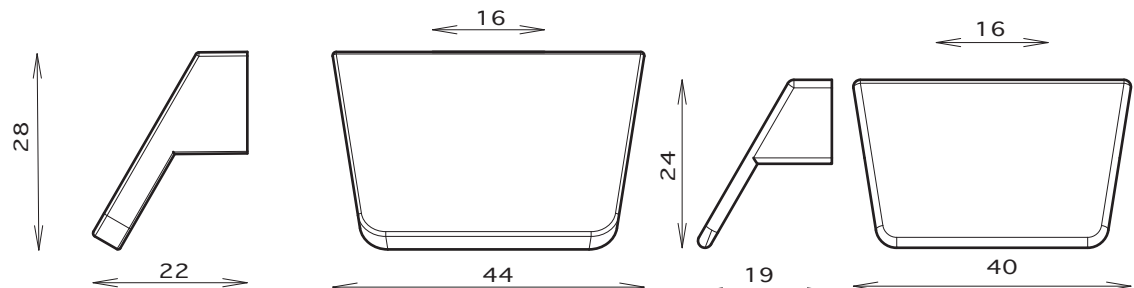

(insert M4)

Art.Nr. item no	mm mm	Lochabstand drilling distance	Farbe colour
8198	40/44	16	unbegrenzte Farbvielfalt endless colour combination



8198/40 I MV2



8198/44I K10 AC1



M144 K1 MF42 LS8

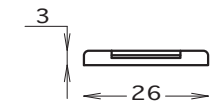

M111 25x1 K1 MF42

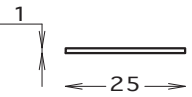

M151 K1 MF42 CF1

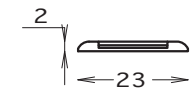

M02 K1 MF42

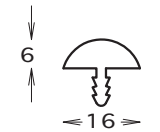

M54 - 5 K1 MF42

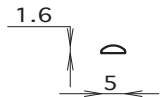

M52 K1 MF42

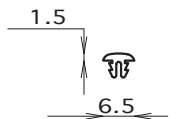

M147/2.5 K1 MF42



M147/3.5 K1 MF42



8236/180 MF42 DE

8214/180 MF42 DE

8216/180 MF42 DE

8208/180 MF42 DE

8217/140 MF42 DE

8237/MF42 DE

0839/170 MF42 MT1

8013/148I MT1 MF42

8016/173 MF42 MT1

8059/240 MF42 MT1

8017/175 MF42 MT1

- 32
- 64
- 96
- 128
- 160
- L



G1



G7



E2



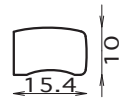

8144



8192



8219

8219/180 LS7

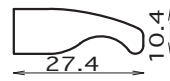

8216



8219

8192/180 LS8

8216/180 LS7

8144/180 LS8

Art.Nr. item no	mm mm	Lochabstand drilling distance	Farbe colour
8144	100	64	unbegrenzte Farbvielfalt endless colour combination
8192	166	128	
8193	200	160	
8216	350	160x2	
8219	500	160x3	
(L) Length/ (x) Drilling Distance			Upon Request



64

96

128

160

L

50



8193/500 LS8

64

96

128

160

L

51



Bronze



0104/60 MV116

MV116

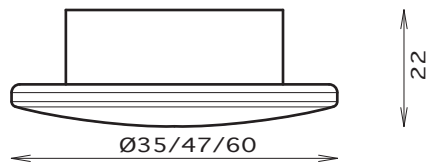

0104/60 MV116



Titanium

MV104



8215/137 MV104



8014/184 MV104



8210/109 MV104



8183/144 MV104



8209/72 MV104



8183/80 MV104



Crystaline

8193

64

96

128

160

L

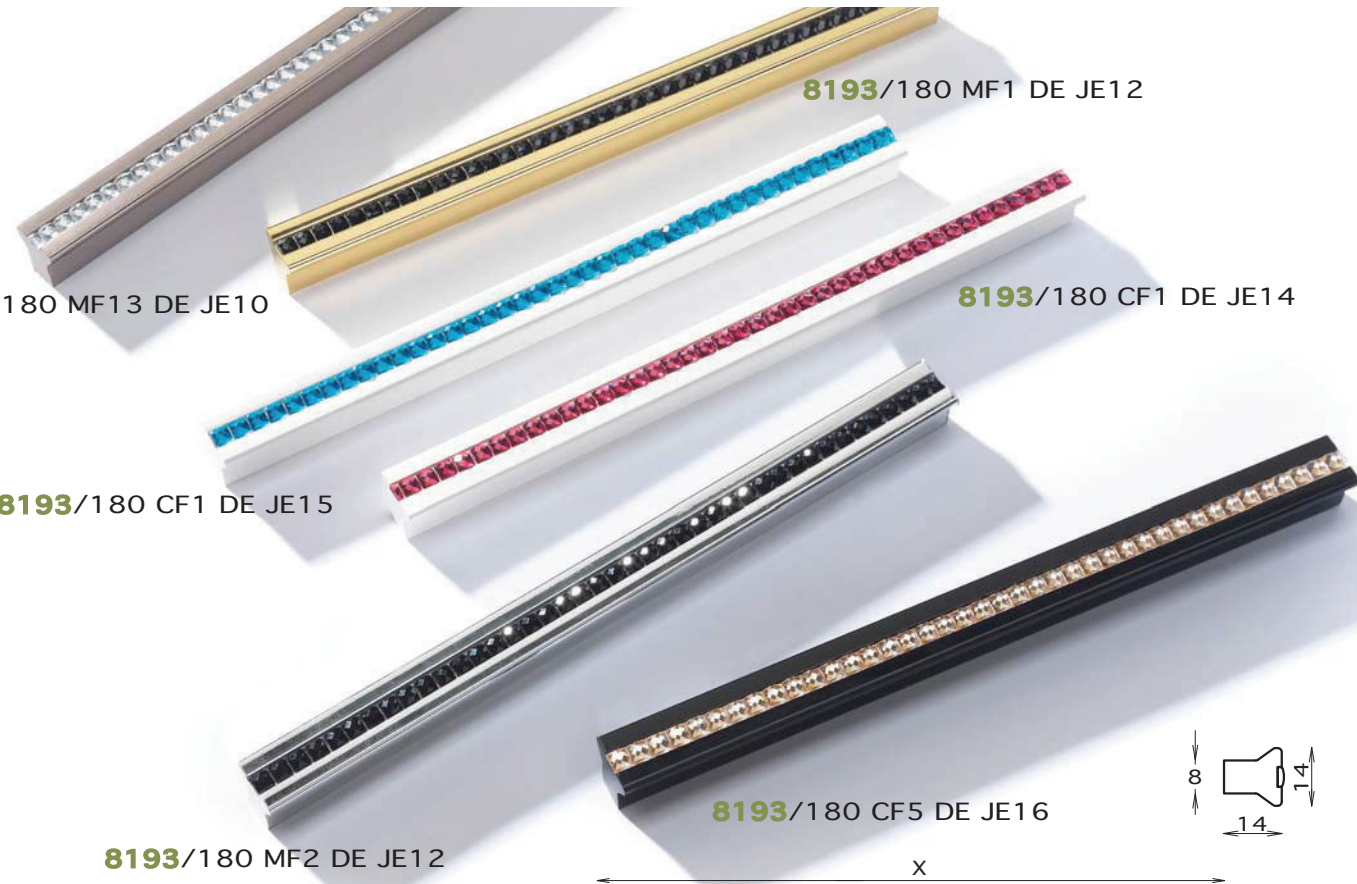

8193/180 MF13 DE JE10

8193/180 MF1 DE JE12

8193/180 CF1 DE JE14

8193/180 CF1 DE JE15

8193/180 MF2 DE JE12

8193/180 CF5 DE JE16

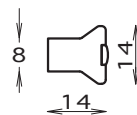

Art.Nr. item no	mm mm	Lochabstand drilling distance	Farbe colour
8193 JE	100	64	unbegrenzte Farbvielfalt endless colour combination
	166	128	
	200	160	
	350	160x2	
	500	160x3	
(L) Length/ (x) Drilling Distance			Upon Request

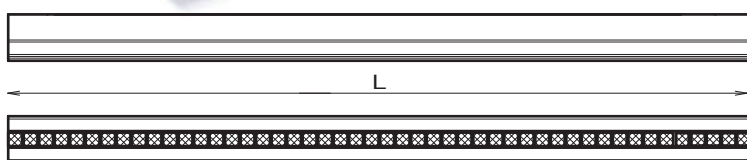

Crystaline

8193

64

96

128

160

L



M145/1000 JE12

8193/180 CF5 DE JE16



M144/1000 MF2 JE10 MF2

M144/1000 CF5 JE10 LS7

M144/1000 MF2 JE12

M144/1000 MF1 JE16

M144/1000 CF1 JE12

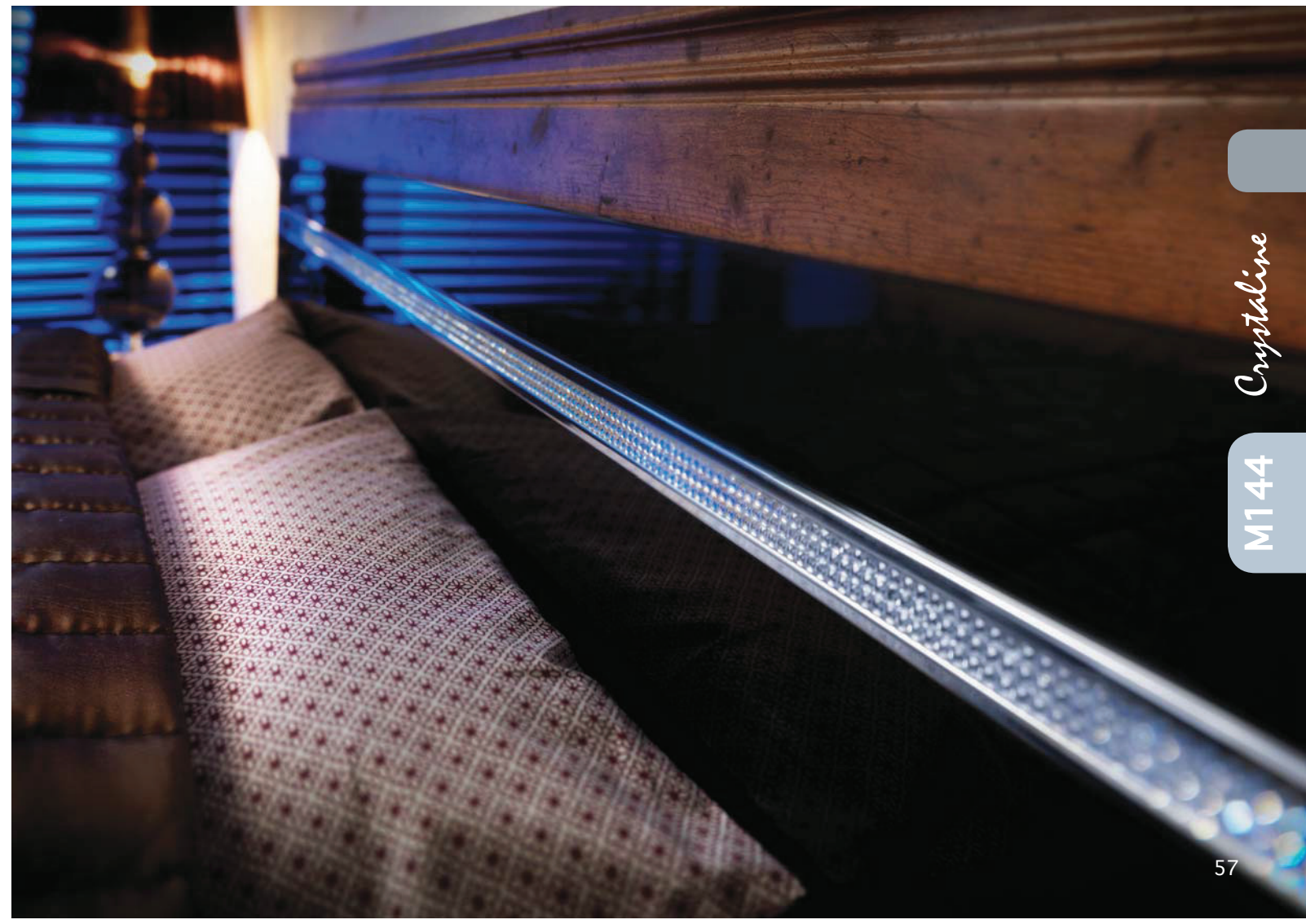
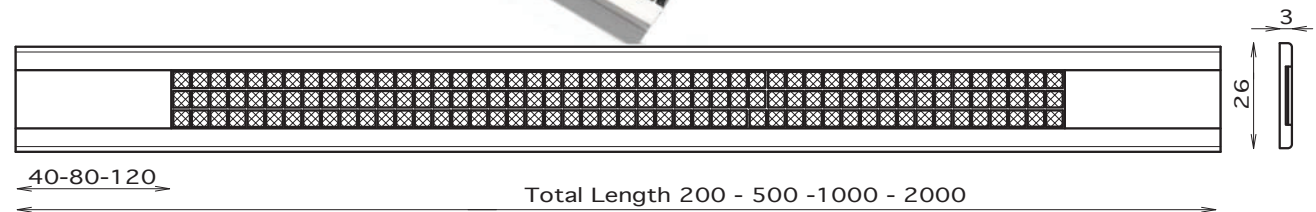



Crystalline collection

M144 MF2 JE10



Z11 MF2 JE10

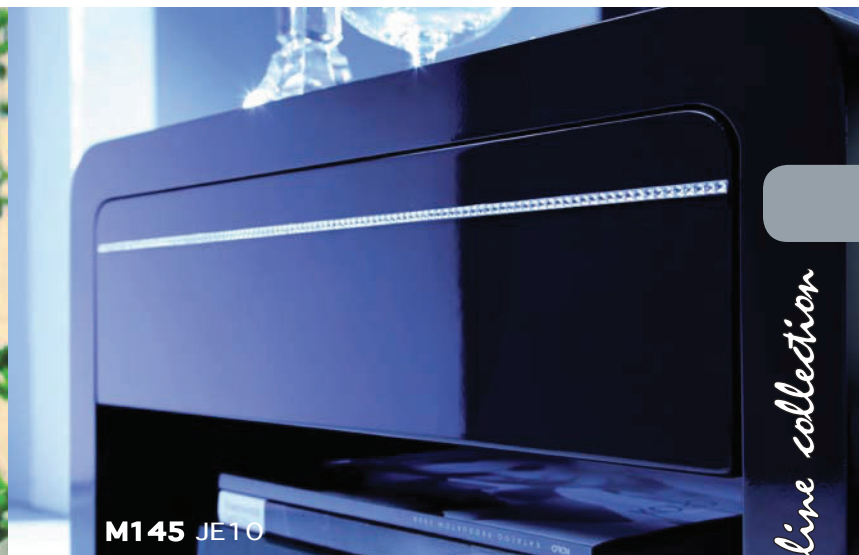

M145 JE10

Crystalline collection



M149 JE12



M151 MF2 JE10



2.5



2.3



2.1



2.1



2.3





0592/124I GL36 JE10

8213/197 MF2 JE12 GL35



8213/197 CF1 JE15 GL 36

8213/197 MF2 CF1 J12 GL36



8121/152 GL35 JE10

8121/152 I MT3 JE16



8121/152 I MTI JE12



0592/124I MTI JE12

0592/124I GL36 JE14

0592/124I MTI06 JE 16

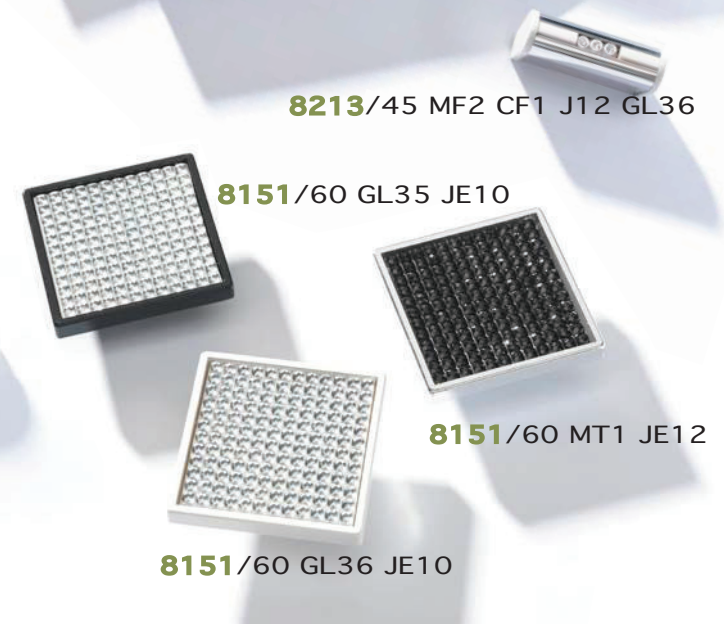

8213/45 MF2 CF1 J12 GL36

8151/60 GL35 JE10

8151/60 MT1 JE12

8151/60 GL36 JE10



8223/169 I GL35 JE10

8223/41 I GL35 JE10

8223/169 I GL36 JE10

8165 /100 GL35 JE12

8165 /100 MTI JE10

8223/41 I GL36 JE10



8216/344T AC14 MV11



Art.Nr. item no	mm	Lochabstand drilling distance	Farbe colour
8193	100	64	unbegrenzte Farbvielfalt endless colour combination
8216	166	128	
	200	160	
	350	160x2	
	500	160x3	
(L) Length/ (x) Drilling Distance			Upon Request

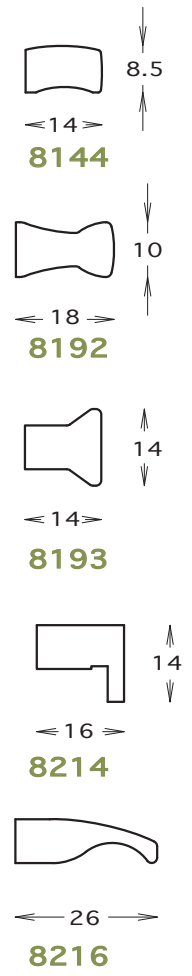
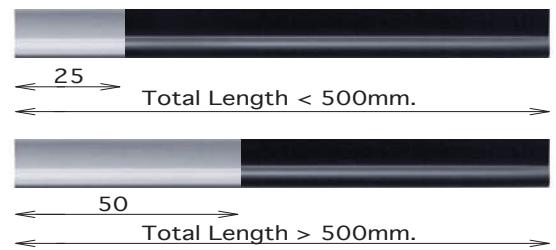

8193/344T AC1 GL35



Dual effect collection

8231/170 KPC1 MV11 MV11



8059/176 SN1 GL36

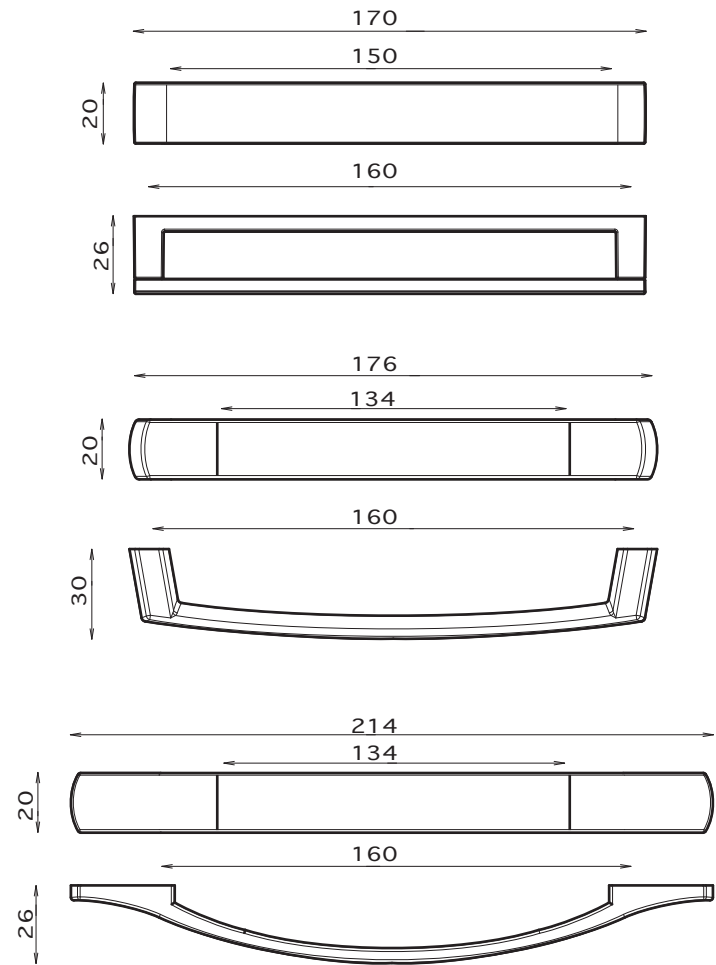

160

Art.Nr. item no	mm	Lochabstand drilling distance	Farbe colour
8014	214	160	unbegrenzte Farbvielfalt endless colour combination
8059	176		
8231	170		

64



Dual effect collection

8014/214 | AC1 MV2

160

65

▶ SIRO produziert 4 Kategorien von Profilen... /
SIRO also produces 4 groups of profiles...

▶ ...Weitere
detailliertere
Informationen
zu unserem
Profilprogramm
finden Sie bitte
in einem speziellen
Katalog / ...more
information about
the profiles
you will find in
our catalogue

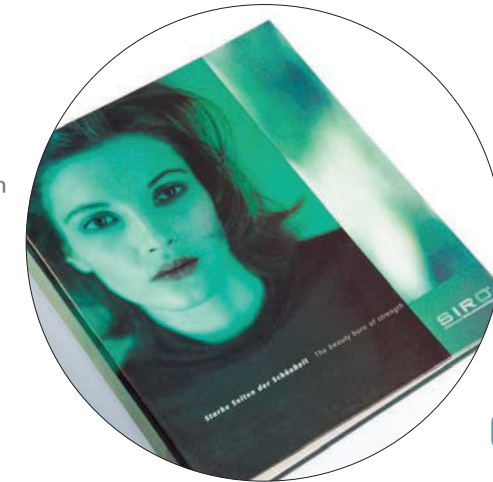

1 Bilderrahmenprofil /
picture frame profiles

2 Möbelkanten /
furniture edging profiles

3 Dekoprofile /
decorative profiles

4 Technische Profile /
technical profiles



▶ die wichtigsten Farben / the most important colours

<p>AN Kunststoff patiniert/ Patina effect</p>						<p>MT Kunststoff - metallisiert/ plastic - metallized</p>					
	AN2	AN3	AN5	AN10	AN11		MT1	MT3			
<p>MV Kunststoff - metallfärbig lackiert/ Plastic - lacquered in metallic colours</p>											
	MV106	MV2	MV10	MV11	MV7	MV104	MV114	MV116			
<p>CP Kunststoff - Holzeffekt/ plastic - wood effect</p>											
	CP4G	CP4M	CP103G	CP139G	CP123M	CP130M	CP133M	CP195M			
<p>SN transparent Effekt/ transparent effect</p>							<p>T Kunststoff - Gummieffekt (Soft Touch)/ plastic - rubber effect</p>				
	SN1	SN6	KGSA6	SNT3	SNT6	SNT8		T7			
<p>G Galvanisiert/ galvanized</p>								<p>GF Glass/ glas</p>			
	G1	G7	E2						GF1	GF2	GF3
<p>GL Hochglänzend/ high glossy</p>											
	GL35	GL36	GL37	GL36	GL36	GL36					

unbegrenzte Farbvielfalt / endless colour combination



▶ Wenn Sie größere Farbvielfalt benötigen/
if you want more colours...

...gibt Ihnen Siro die unbegrenzte Farbvielfalt!/
SIRO gives you endless colour combination!

▶ Artikel Index / pages index

Art.Nr. item no	seite page
0104	52
0592	60
0839	47
8013	47
8014	48-53-64
8016	47
8017	47
8059	47-48-64
8072	26
8121	61
8144	50-62
8151	60
8165	61
8183	53
8192	50-62
8193	50-54-62
8198	44
8208	47
8209	53
8210	53
8213	60

Art.Nr. item no	seite page
8214	47-62
8215	53
8216	47-50-62
8217	47
8219	50
8223	61
8225	2
8226	4
8229	6-50
8231	8-64
8232	10
8233	8
8234	12
8235	14
8236	16-47
8237	18-47
8238	20
8239	22
8240	20
8241	24-48
8242	26

Art.Nr. item no	seite page
8243	28-48
8244	30
8245	32
8246	34
8247	36
8248	38
8249	40
8250	42
M02	46
M52	46
M54	46
M111	46
M144	46-56
M145	55-59
M147	46
M149	59
M151	46
SP137	59
SP138	59
Z11	59