



Square Bar

0839

L



0839/500 R2000 MF13 MV7

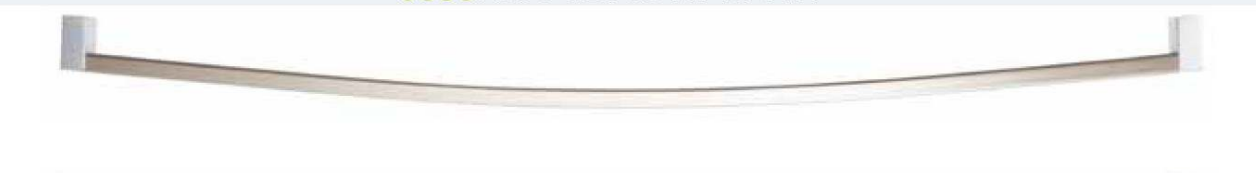

0839/500 R2000 HF60 MV2

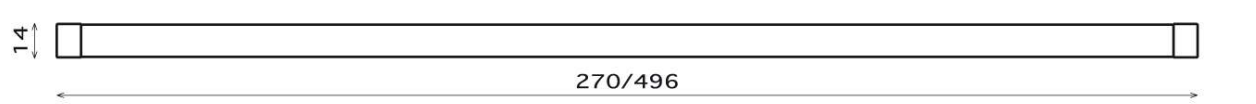
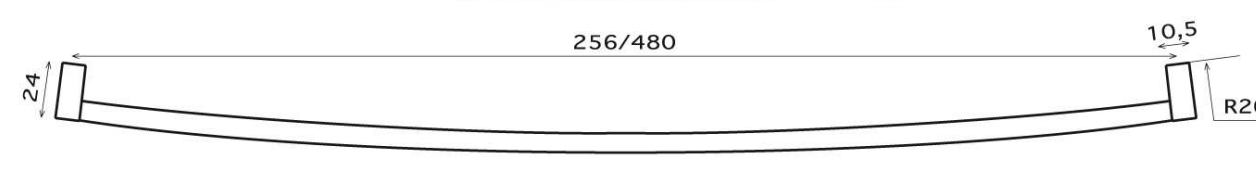

Art.Nr. item no	mm mm	Lochabstand drilling distance	Farbe colour
0839 R2000	270 496	256 480	unbegrenzte Farbvielfalt endless colour combination
(R) Radius / (L) Length		Upon Request	



0839/500 R2000 MF13 MV7



Square Bar

0839

L



Ellipse Bar

8016



8016/500 R2000 HF60 MV2



8016/500 R2000 MF18 MV2

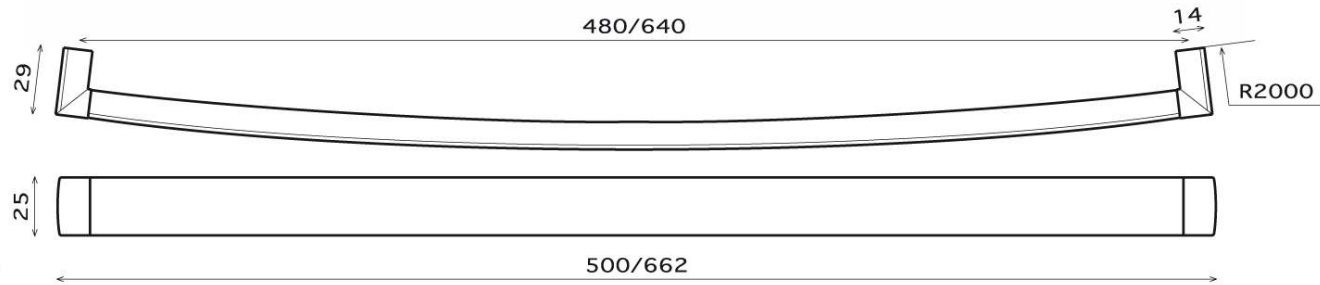

Art.Nr. item no	mm mm	Lochabstand drilling distance	Farbe colour
8016 R2000	500 662	480 640	unbegrenzte Farbvielfalt endless colour combination
(R) Radius / (L) Length		Upon Request	



8016/500 R2000 HF60 MV2



Ellipse Bar

8016

L



Creatio Bar

8144

L

6



8144/500 R2000 MF18 DE



8144/500 R2000 MF2 DE



8144/220 R2000 MF13 DE

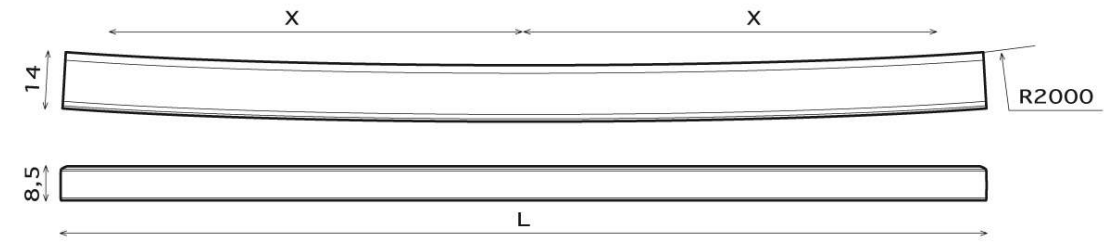

Art.Nr. item no	mm mm	Lochabstand drilling distance	Farbe colour
8144 R2000	335	160x2	unbegrenzte Farbvielfalt endless colour combination
	500	160x3	
	657	160x4	
(R) Radius / (L) Length / (X) Drilling Distance			Upon Request

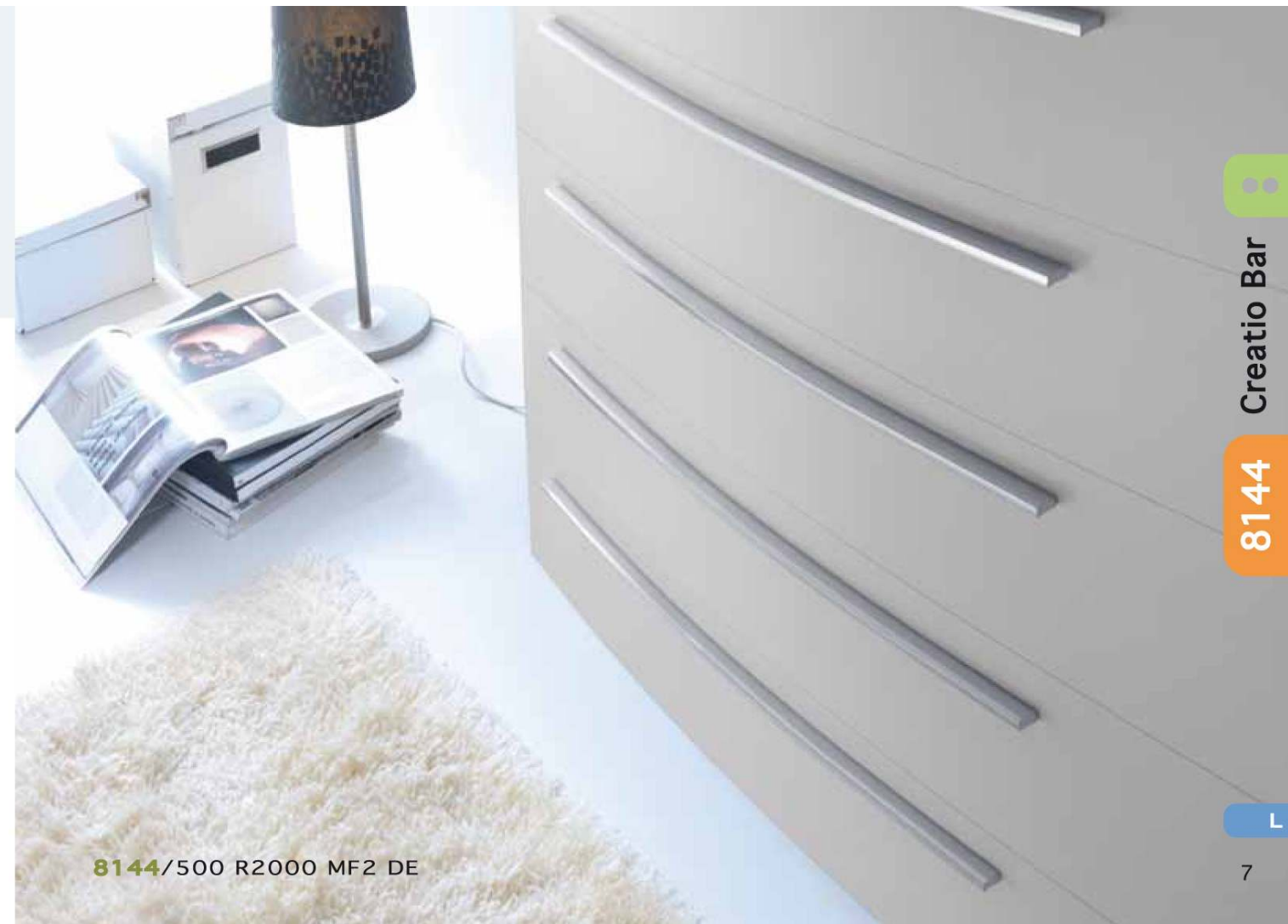
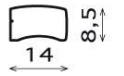

8144/500 R2000 MF2 DE



Creatio Bar

8144

L

7





unbegrenzte Farbvielfalt  
endless colour combination



8183/144 GL35

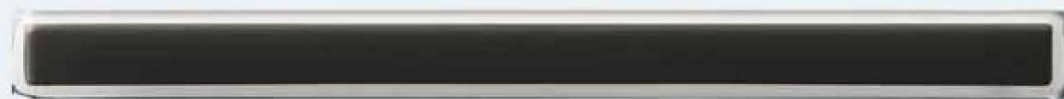

8183/148 AC21 AC1



8183/148 AC32 AC1



8183/80 MV106



Art.Nr. item no	mm	Lochabstand drilling distance	Farbe colour
8183	80/84	64	unbegrenzte Farbvielfalt endless colour combination
	144/148	128	



8183/148 AC31 AC1

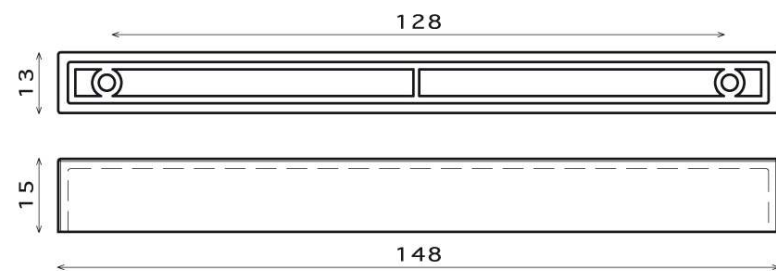

8183/148

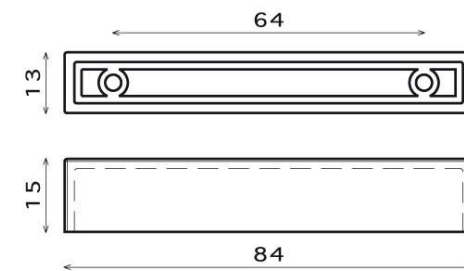

8183/84





8187/150 MT1 GL35



8187/150 MT1 GL36



8187/150 MT1 MT1



8187/150 MT1 MV2



8187/150 MT1 GL35



8187/150 MT1 MT1



8187/150 MT1 GL36



8187/150 MT1 MV2

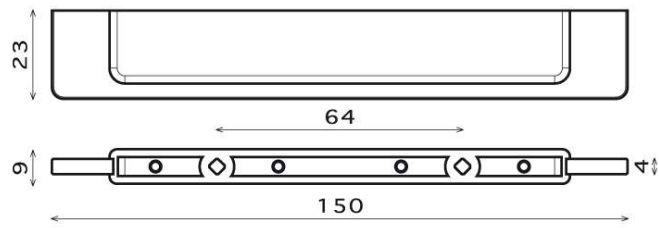

Art.Nr. item no	mm	Lochabstand drilling distance	Farbe colour
8187	150	64	unbegrenzte Farbvielfalt endless colour combination



8187/150 MT1 GL35



Future Bar

8190

L



8190/500 MF2 DE



8190/180 MF13 DE



8190/180 MF18 DE

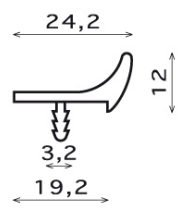
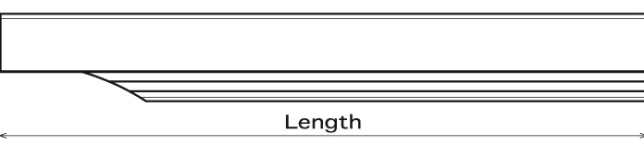

Art.Nr. item no	mm mm	Lochabstand drilling distance	Farbe colour
8190	180 500		unbegrenzte Farbvielfalt endless colour combination
(L) Length		Upon Request	



Future Bar

8190

L



8190/180 MF18 DE

••

Key Hole

8192

64

96

128

160

L

14



8192/500 CF1 DE



8192/500 MF13 DE



8192/500 HF60 HG DE



8192/500 MF18 DE

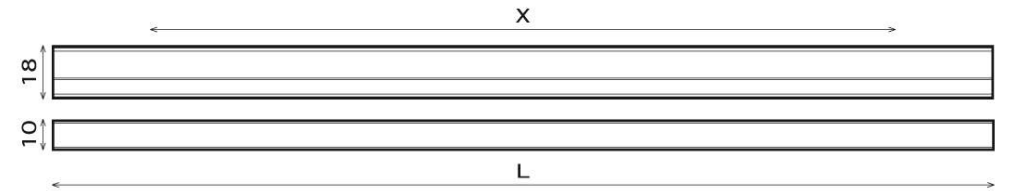

Art.Nr. item no	mm mm	Lochabstand drilling distance	Farbe colour
8192	100	64	unbegrenzte Farbvielfalt endless colour combination
	166	128	
	200	160	
	350	160x2	
	500	160x3	
(L) Length / (X) Drilling Distance			Upon Request

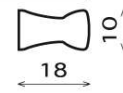

••

Key Hole

8192

64

96

128

160

L

15



8192/500 MF13 DE





8193 CF1



8193 HF60



8193 CF5

unbegrenzte Farbvielfalt  
endless colour combination



8193/500 R2000 MF18 DE



8193/220 R2000 MF18 DE



8193/500 R2000 MF13 DE

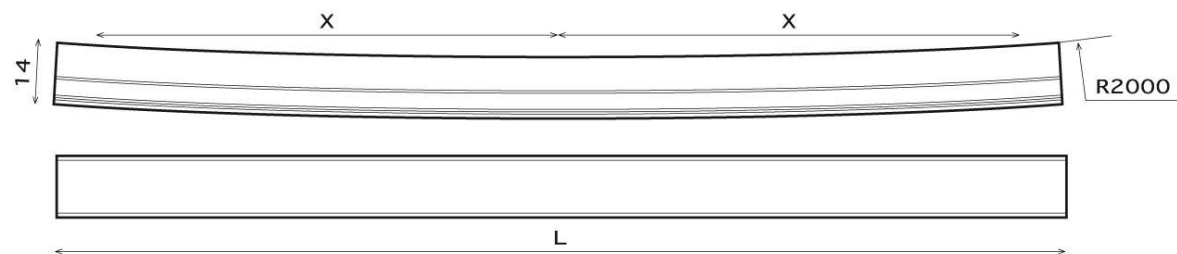

Art.Nr. item no	mm mm	Lochabstand drilling distance	Farbe colour
8193 R2000	335	160x2	unbegrenzte Farbvielfalt endless colour combination
	500	160x3	
	657	160x4	
(R) Radius / (L) Length / (X) Drilling Distance			Upon Request

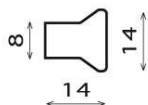

8193/500 R2000 MF2 DE



T-Bar

8193

L



T-Bar

8193

L



T-Bar

8193

64  
96  
128  
160  
L



8193/600MF2 DE



8193/600MF18 DE



8193/600MF2 DE

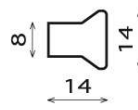
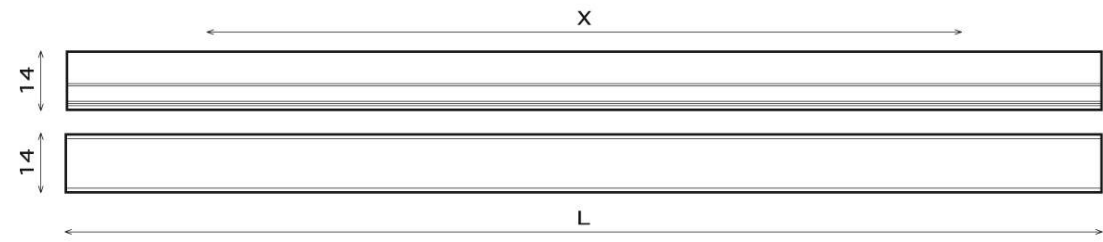

Art.Nr. item no	mm mm	Lochabstand drilling distance	Farbe colour
8193	100	64	unbegrenzte Farbvielfalt endless colour combination
	166	128	
	200	160	
	350	160x2	
	500	160x3	
(L) Length / (X) Drilling Distance			Upon Request



8193/600MF18 DE



T-Bar

8193

64  
96  
128  
160  
L





8194 MT1 SN1



8194 MT1 SN24



8194 SK358 SN19



8194 MT1 K1



8194 MT1 CP195 M

unbegrenzte Farbvielfalt  
endless colour combination

8194/24 MV2 SN24



8194/24 SK358 SN19



8194/24 MT1 K1

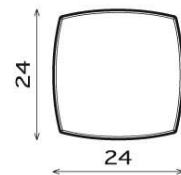
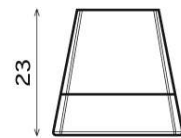

(insert M4)

Art.Nr. item no	mm	Lochabstand drilling distance	Farbe colour
8194	24		unbegrenzte Farbvielfalt endless colour combination







8195/24 SK358 SN19



8195/24 MT1 SN1



8195/24 MV2 SN24

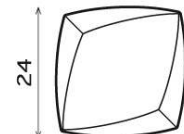
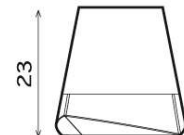

(insert M4)

Art.Nr. item no	mm	Lochabstand drilling distance	Farbe colour
8195	24		unbegrenzte Farbvielfalt endless colour combination



8195/24 SK358 SN19



8196/83 MT1 SN1



8196/83 MV2 SN11



8196/83 MV2 SN24



8196/83 SK358 SN19

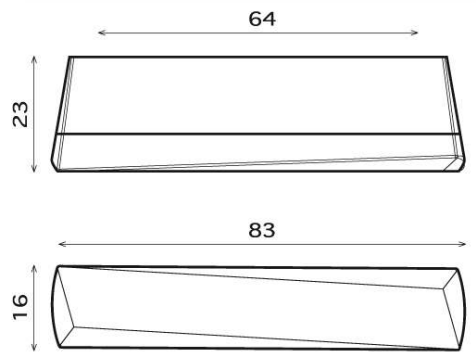

Art.Nr. item no	mm	Lochabstand drilling distance	Farbe colour
8196	83	64	unbegrenzte Farbvielfalt endless colour combination

design by DESIGN *Die Gabel*



8196/83 MV2 SN11



Catchy

8197

96

26



8197/110 GL35 GL36



8197/110 MV2 MT1



8197/110 GL35 MT1



8197/110 MV2 MT1

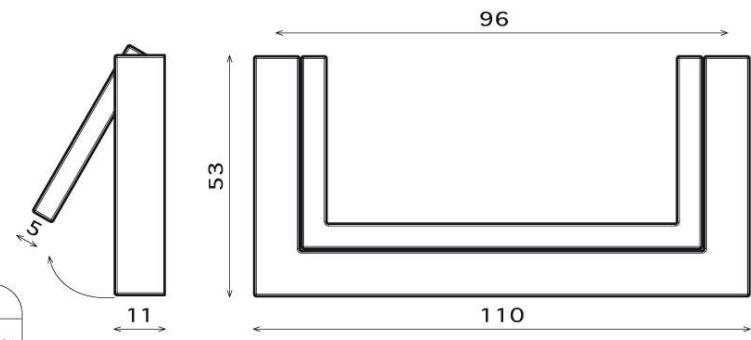

Art.Nr. item no	mm mm	Lochabstand drilling distance	Farbe colour
8197	110	96	unbegrenzte Farbvielfalt endless colour combination



Catchy

8197

96

27



8197/110 GL35 MT1





8198/40 | CP195 M



8198/40 | MV2

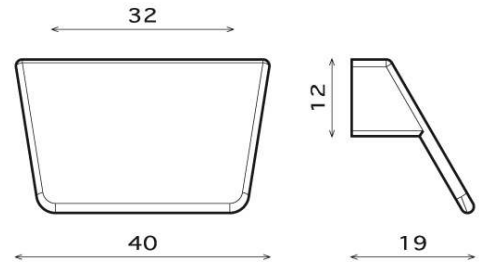

Art.Nr. item no	mm mm	Lochabstand drilling distance	Farbe colour
8198	40	32	unbegrenzte Farbvielfalt endless colour combination



8198/40 | MV2

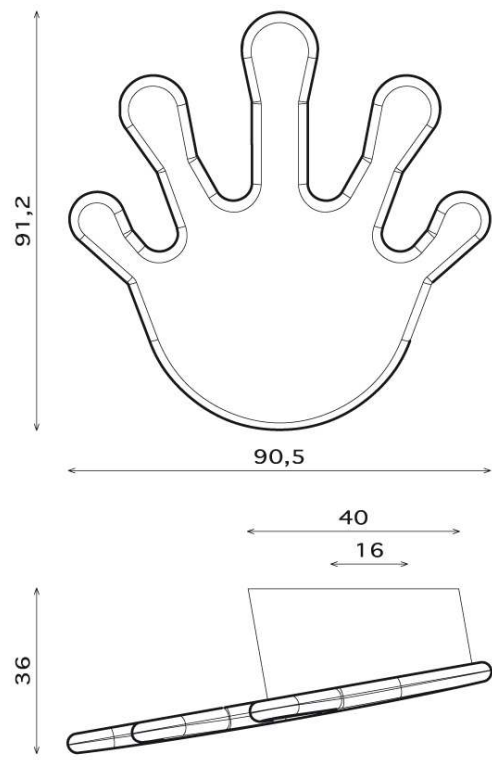

Art.Nr. item no	mm mm	Lochabstand drilling distance	Farbe colour
8199	92	16	unbegrenzte Farbvielfalt endless colour combination



8199/92 KM108



8199/92 GL38



8200 GL35



8200 GL36



8200 GL39



8200 GL41

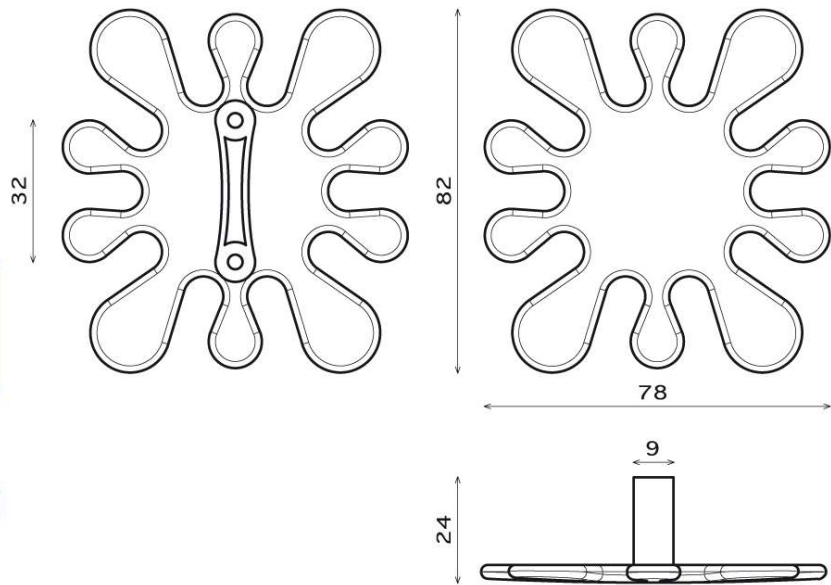

(insert M4)

Art.Nr. item no	mm mm	Lochabstand drilling distance	Farbe colour
8200	82	32	unbegrenzte Farbvielfalt endless colour combination

unbegrenzte Farbvielfalt  
endless colour combination



8200/82 GL38



8200/82 GL38



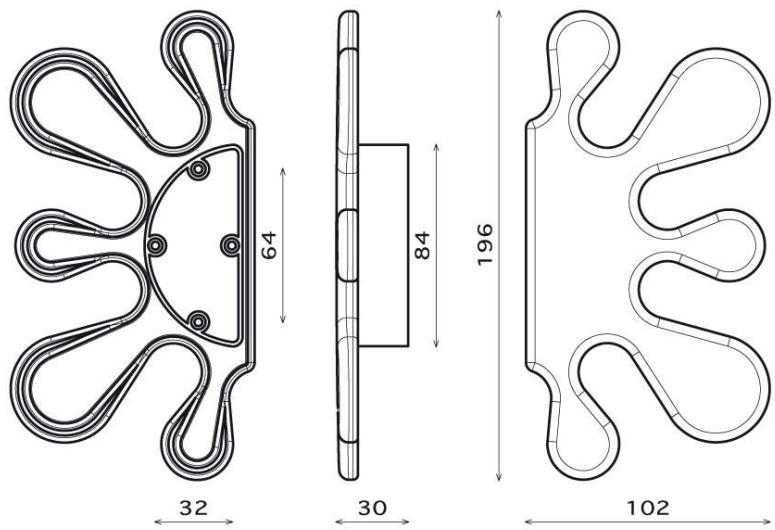

(insert M4)

Art.Nr. item no	mm mm	Lochabstand drilling distance	Farbe colour
8201	196	32 / 64	unbegrenzte Farbvielfalt endless colour combination

unbegrenzte Farbvielfalt  
endless colour combination



8201/196 GL41



8201/196 GL41

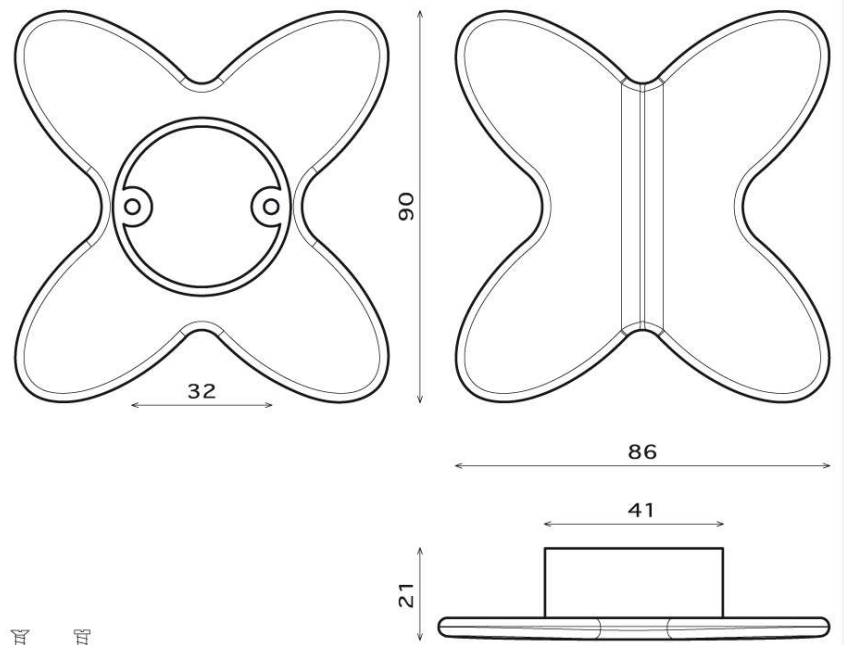

Art.Nr. item no	mm mm	Lochabstand drilling distance	Farbe colour
8202	86	32	unbegrenzte Farbvielfalt endless colour combination

unbegrenzte Farbvielfalt  
endless colour combination



8202/86 KM105



8202/86 GL37



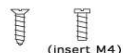
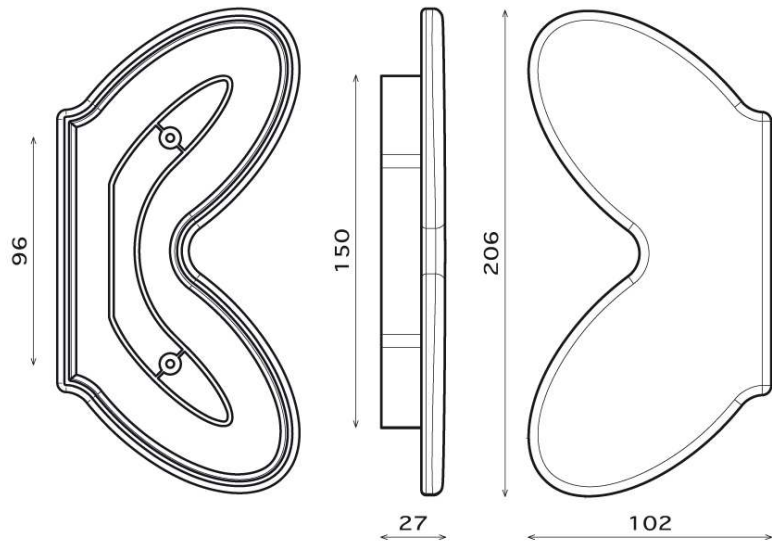

Art.Nr. item no	mm mm	Lochabstand drilling distance	Farbe colour
8203	206	96	unbegrenzte Farbvielfalt endless colour combination

unbegrenzte Farbvielfalt  
endless colour combination



8203/206 GL40



8203/206 GL40





8204/222 CF1 MT1



8204/222 HF60 MV2



8204/510 HF1 MV7



8204/222 CF5 MT1



8204/222 MF18 MT1

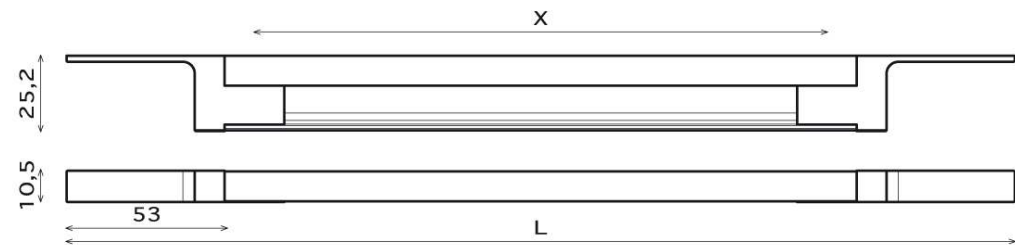

Art.Nr. item no	mm mm	Lochabstand drilling distance	Farbe colour
8204	222 382 510	96 128x2 384	unbegrenzte Farbvielfalt endless colour combination

(L) Length / (X) Drilling Distance      Upon Request

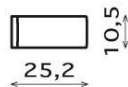

design by **DESIGN** *Diego Sestini*



8204/222 CF5 MT1

64

C Bar

8205

64

96

128

160

L



8205/500 HF1 DE



8205/500 MF2 DE



8205/500 HF60 DE



8205/500 MF18 DE

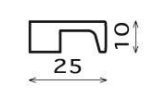
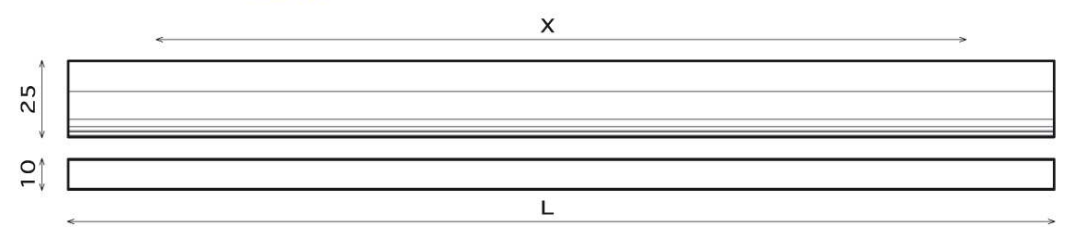

Art. Nr. item no	mm mm	Lochabstand drilling distance	Farbe colour
8205	100	64	unbegrenzte Farbvielfalt endless colour combination
	166	128	
	200	160	
	350	160x2	
	500	160x3	
(L) Length / (X) Drilling Distance			Upon Request

design by DESIGN

42

64

C Bar

8205

64

96

128

160

L



8205/500 HF1 DE

43





8206/500 R2000 MF18 MT1

8206/753 R2000 MF18 MT1

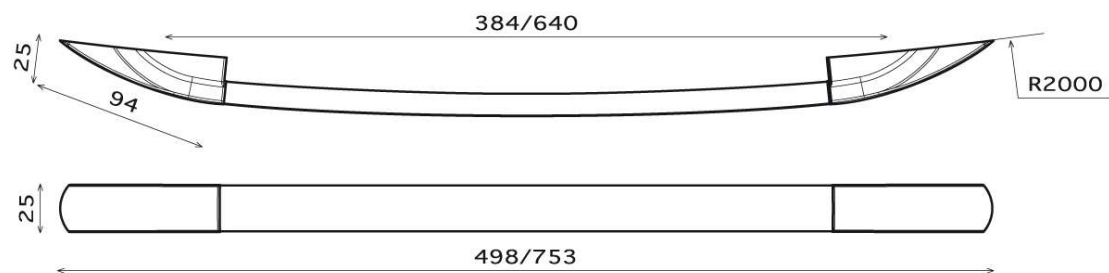
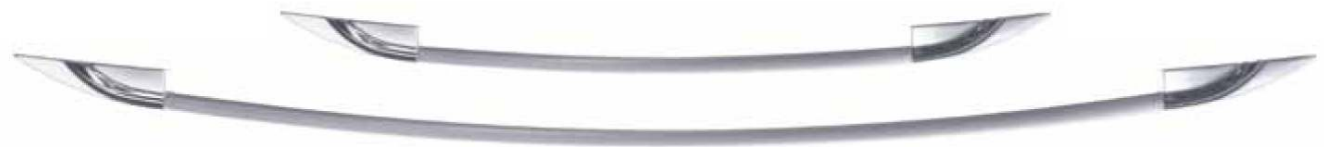

(insert M4)

Art.Nr. item no	mm mm	Lochabstand drilling distance	Farbe colour
8206	498 753	384 640	unbegrenzte Farbvielfalt endless colour combination
(L) Length		Upon Request	



8206/753 R2000 MF18 MT1





8207/72 SK389



8207/166 SK389



8207 SK53



8207 SK327



8207 SK361



8207 SK515

unbegrenzte Farbvielfalt  
endless colour combination

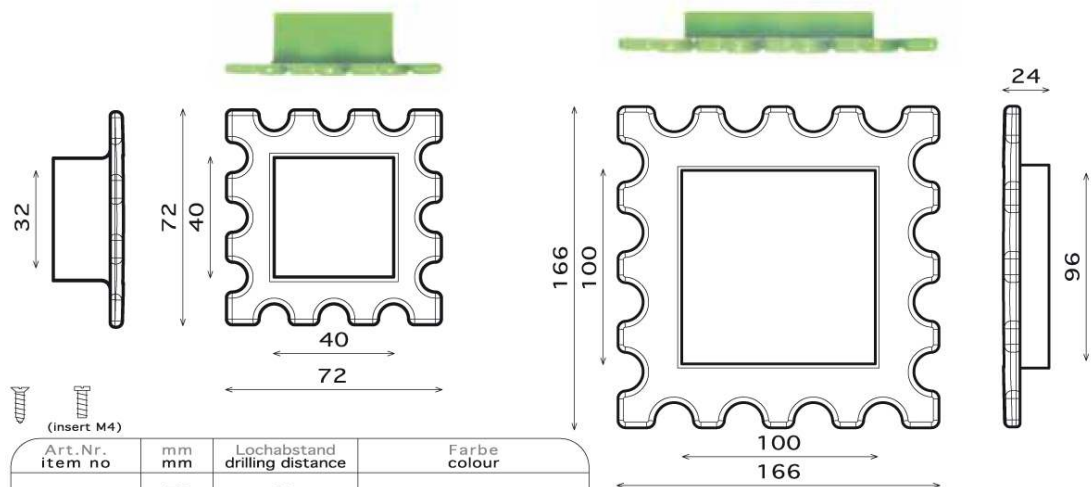

Art.Nr. item no	mm mm	Lochabstand drilling distance	Farbe colour
8207	72 166	32 96	unbegrenzte Farbvielfalt endless colour combination

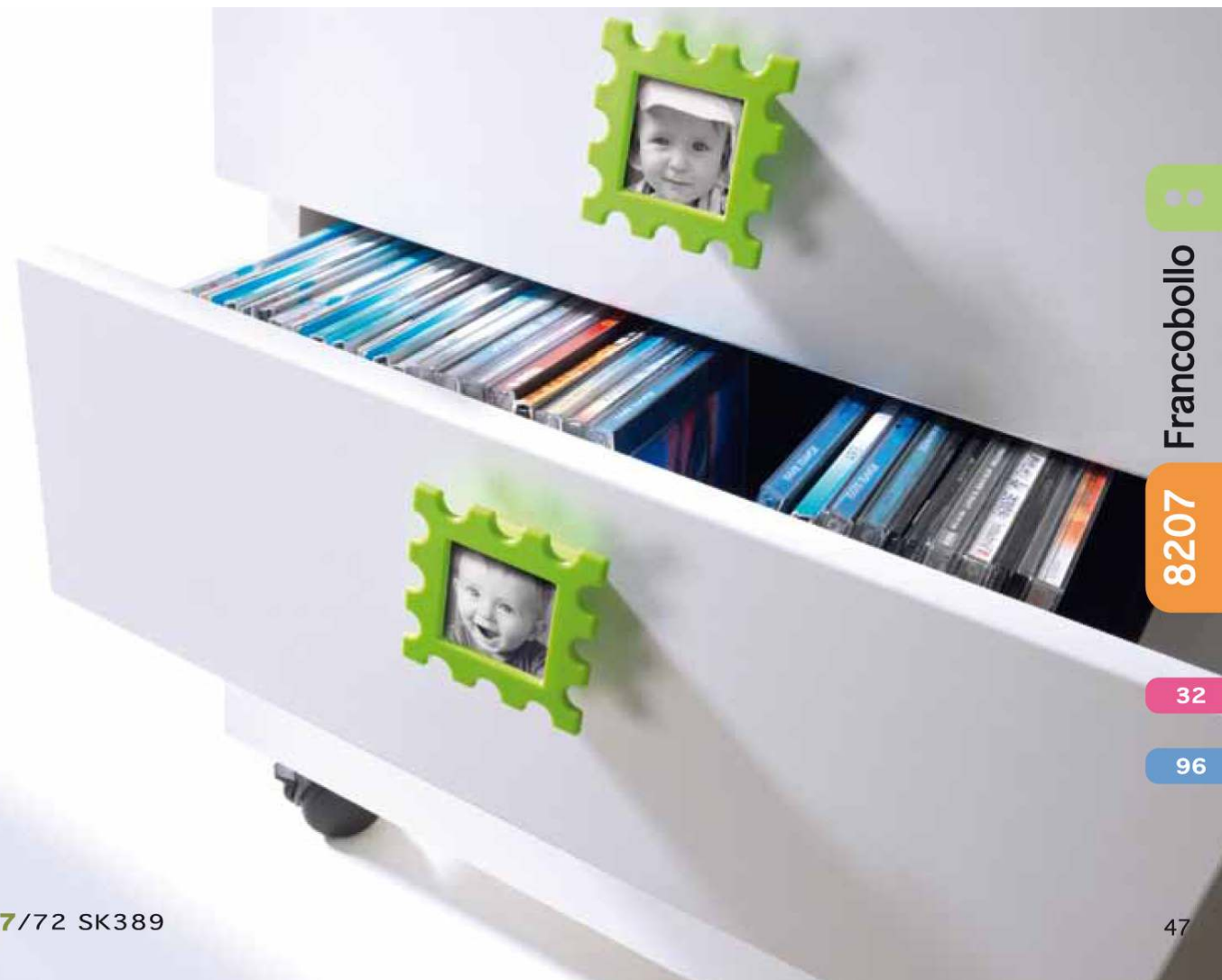

8207/72 SK389



8208/500 K1 CF1 DE



8208/500 SK27 CF5 DE



8208/500 K1 MF2 DE

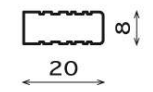
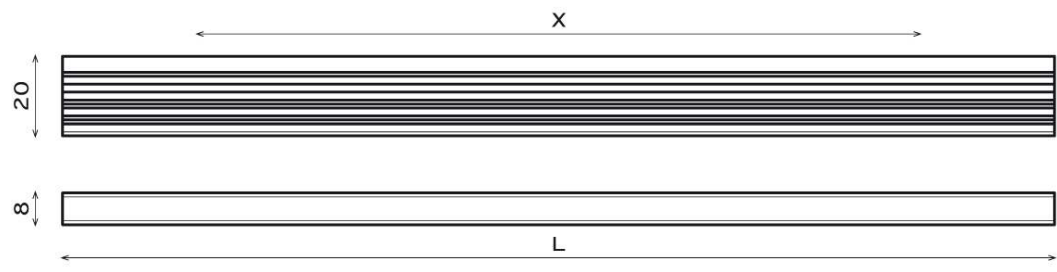

Art.Nr. item no	mm mm	Lochabstand drilling distance	Farbe colour
8208	100	64	unbegrenzte Farbvielfalt endless colour combination
	166	128	
	200	160	
	350	160x2	
	500	160x3	
(L) Length / (X) Drilling Distance		Upon Request	



8208/500 SK27 CF5 DE



Tavola



8209/72 GL35



8209/72 GL36



8209/72 MV7

8209



32



Art.Nr. item no	mm mm	Lochabstand drilling distance	Farbe colour
8209	72	32	unbegrenzte Farbvielfalt endless colour combination

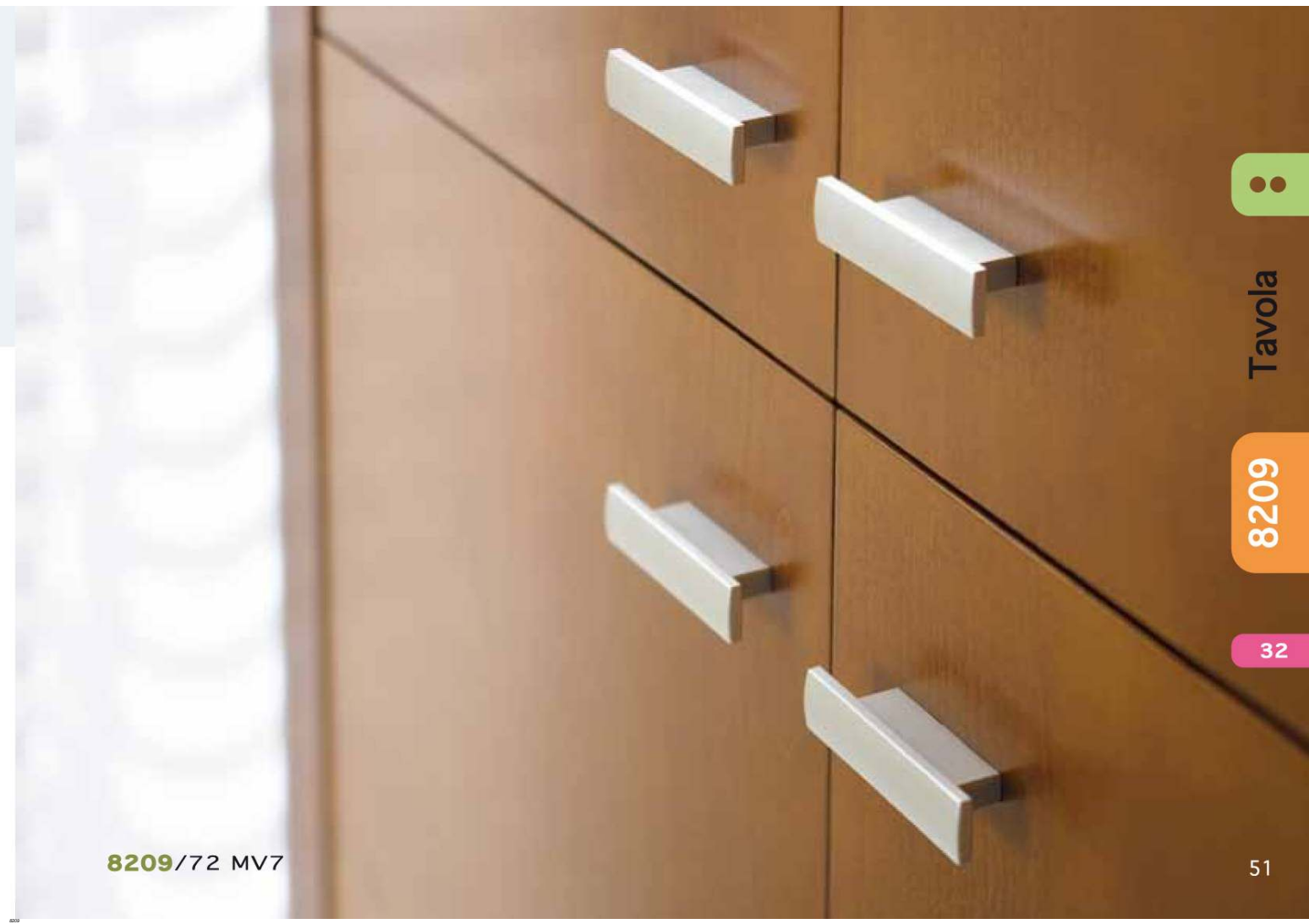
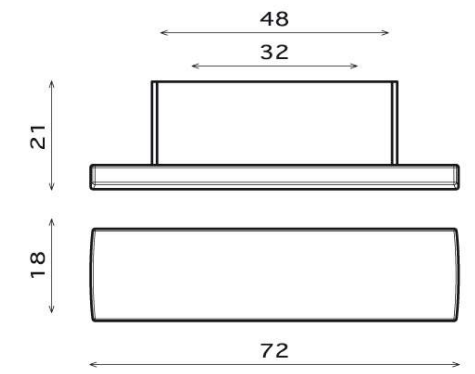

8209/72 MV7



Tavola

8209

32





Umbrella

8210

64  
96



8210/109 MV2



8210/109 MV7

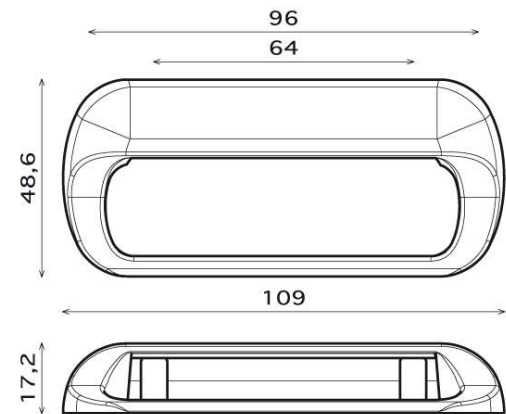

Art.Nr. item no	mm mm	Lochabstand drilling distance	Farbe colour
8210	109	64 / 96	unbegrenzte Farbvielfalt endless colour combination

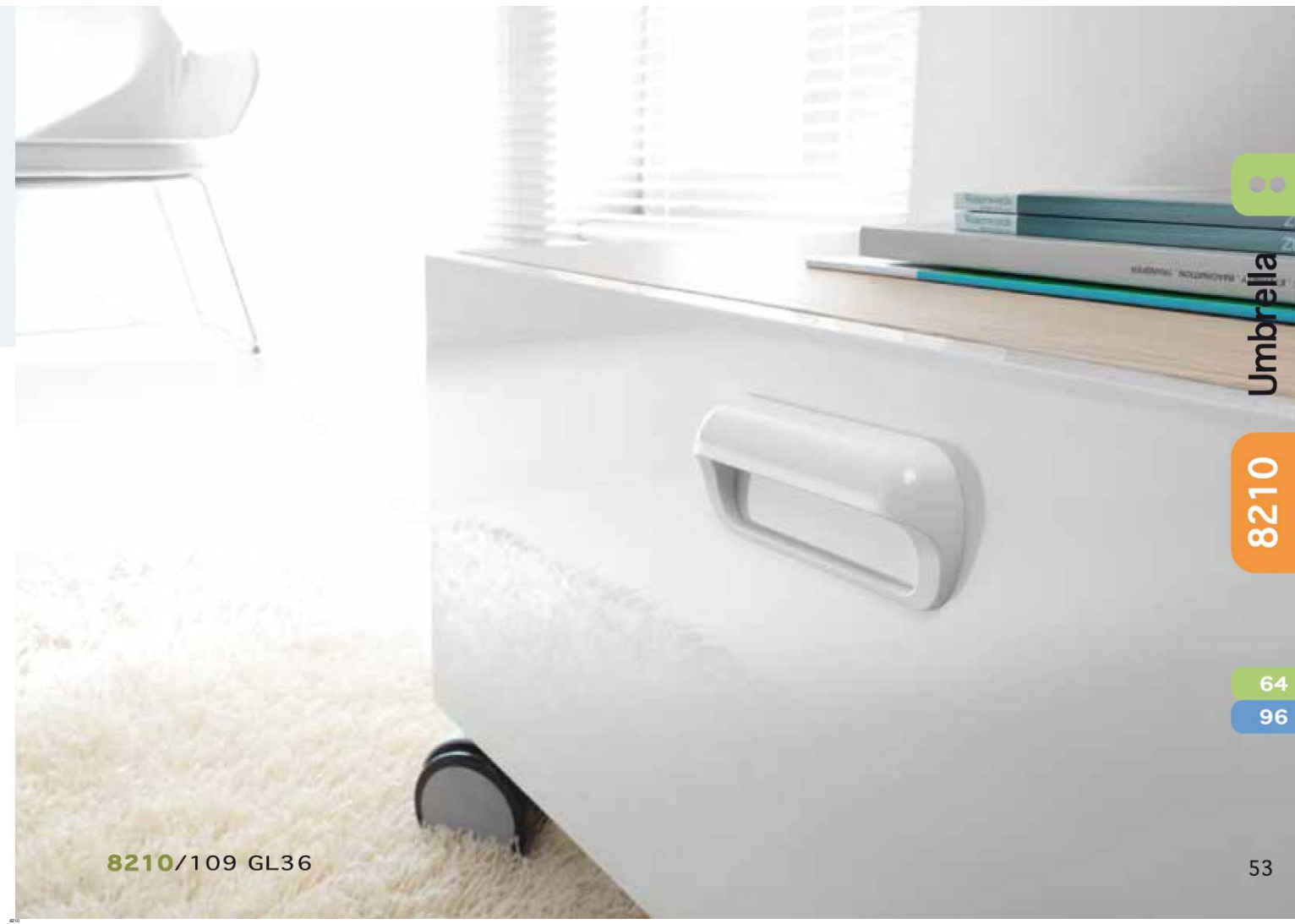

8210/109 GL36



Umbrella

8210

64  
96



Art.Nr. item no	mm mm	Lochabstand drilling distance	Farbe colour
8211	14		unbegrenzte Farbvielfalt endless colour combination

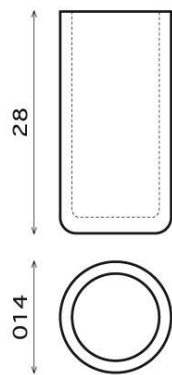

8211/14 AC20 AC1



8211/14 AC21 AC1



8211/14 AC20 AC1



Sweety

8212

32

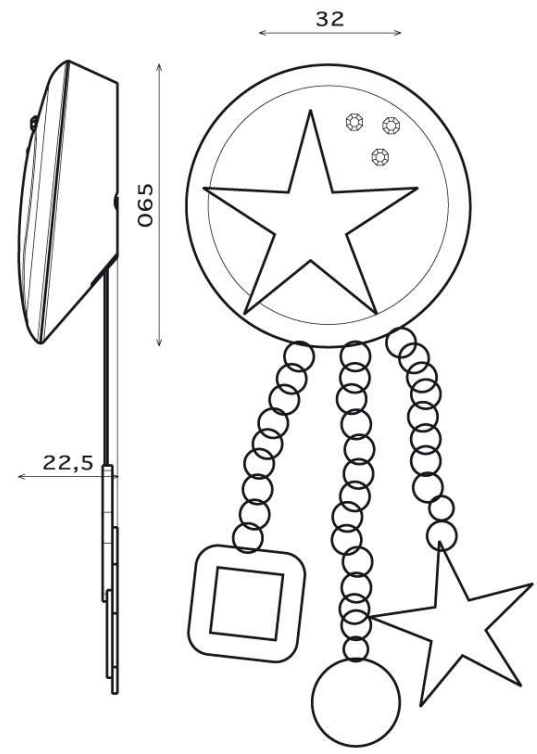

Art.Nr. item no	mm	Lochabstand drilling distance	Farbe colour
8212	65	32	unbegrenzte Farbvielfalt endless colour combination



Sweety

8212

32





8213/165 HF60 MF2 MT1



8213/165 MF2 CF5 GL35



8213/165 MF2 CF5 GL35

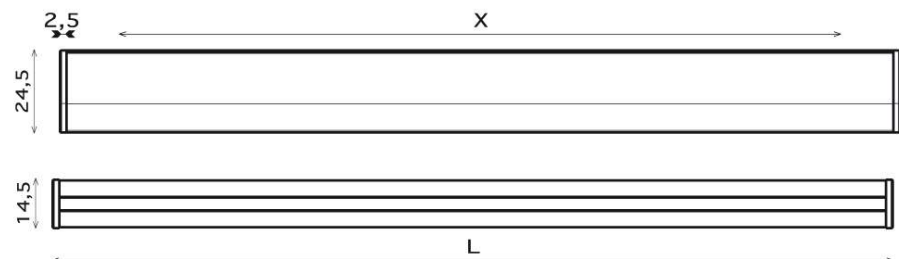

Art.Nr. item no	mm mm	Lochabstand drilling distance	Farbe colour
8213	165	128	unbegrenzte Farbvielfalt endless colour combination
	197	160	
	357	160x2	
(L) Length / (X) Drilling Distance		Upon Request	

8213/165 HF60 MF2 MT1



L-Bar

8214

64

96

128

160

L

60

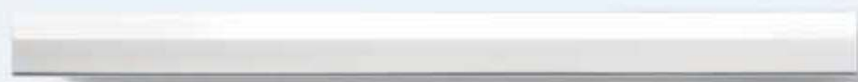

8214/180 CF1 DE

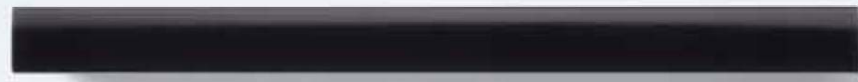

8214/180 CF5 DE



8214/180 MF2 DE

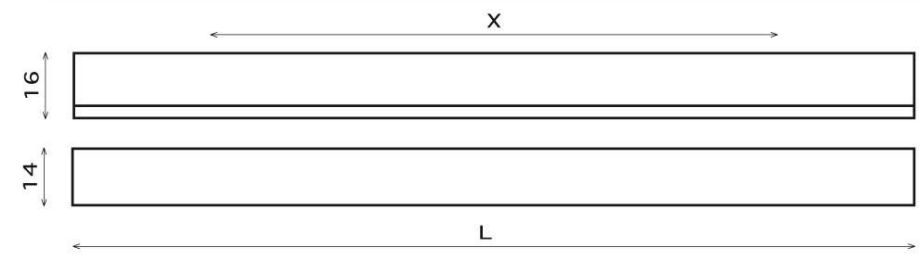

Art.Nr. item no	mm mm	Lochabstand drilling distance	Farbe colour
8214	100	64	unbegrenzte Farbvielfalt endless colour combination
	166	128	
	200	160	
	350	160x2	
	500	160x3	
(L) Length / (X) Drilling Distance			Upon Request

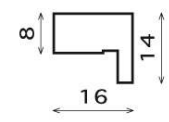

L-Bar

8214

64

96

128

160

L

61

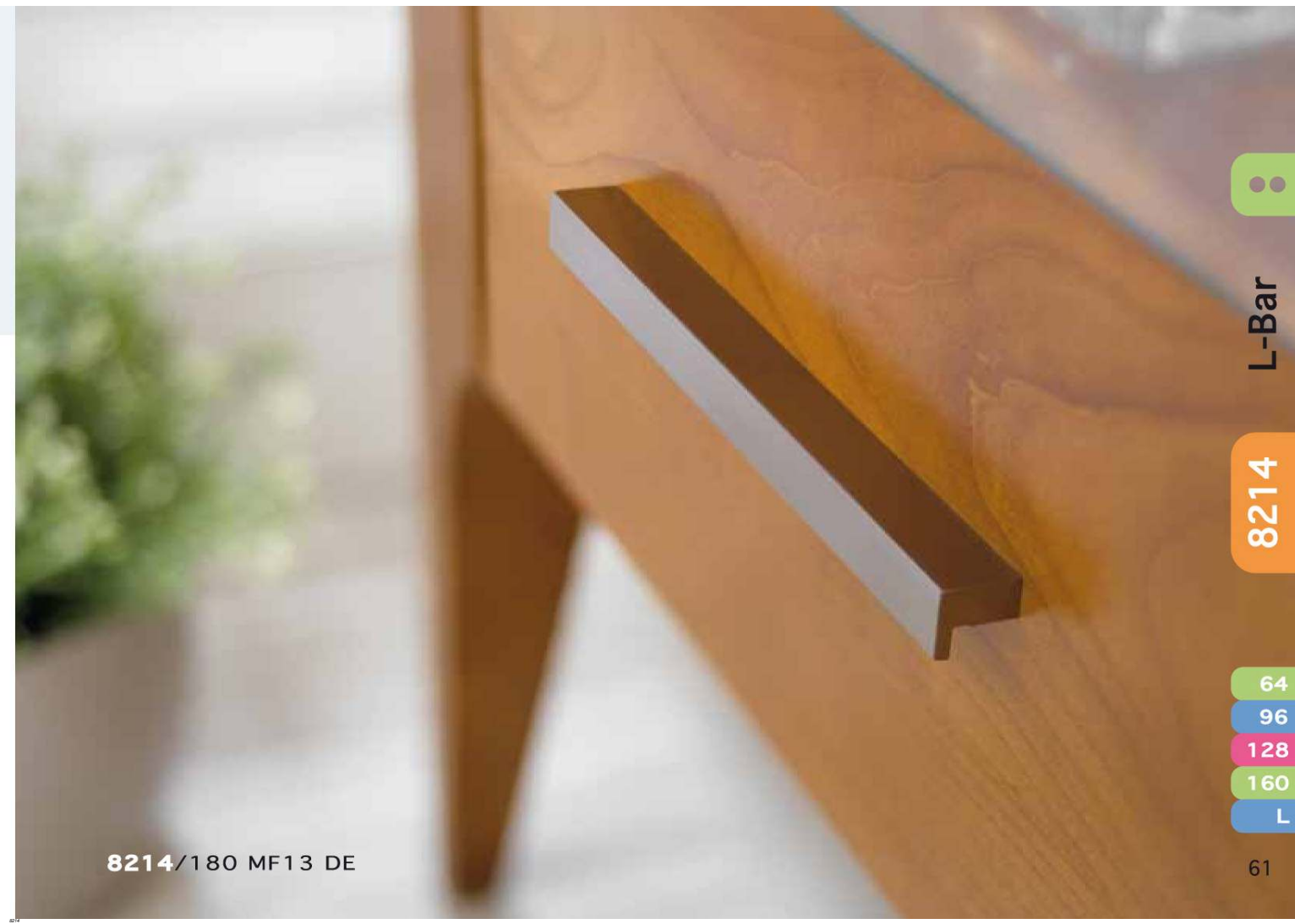

8214/180 MF13 DE



8215/137 MV2



8215/137 MV7

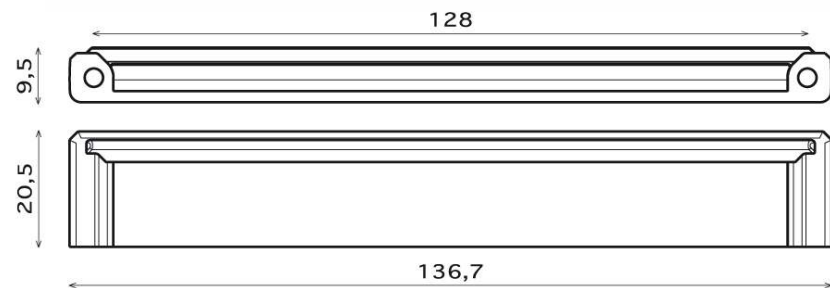

Art.Nr. item no	mm	Lochabstand drilling distance	Farbe colour
8215	137	128	unbegrenzte Farbvielfalt endless colour combination



8215/137 MV2





8216/180 MF2 DE



8216/180 HF60 DE

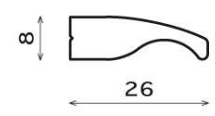
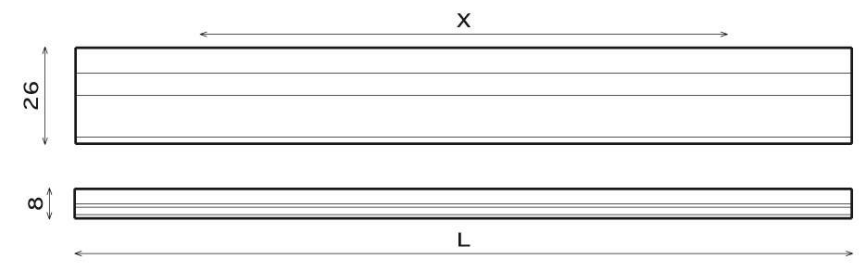

Art.Nr. item no	mm mm	Lochabstand drilling distance	Farbe colour
8216	100	64	unbegrenzte Farbvielfalt endless colour combination
	166	128	
	200	160	
	350	160x2	
	500	160x3	
(L) Length / (X) Drilling Distance			Upon Request

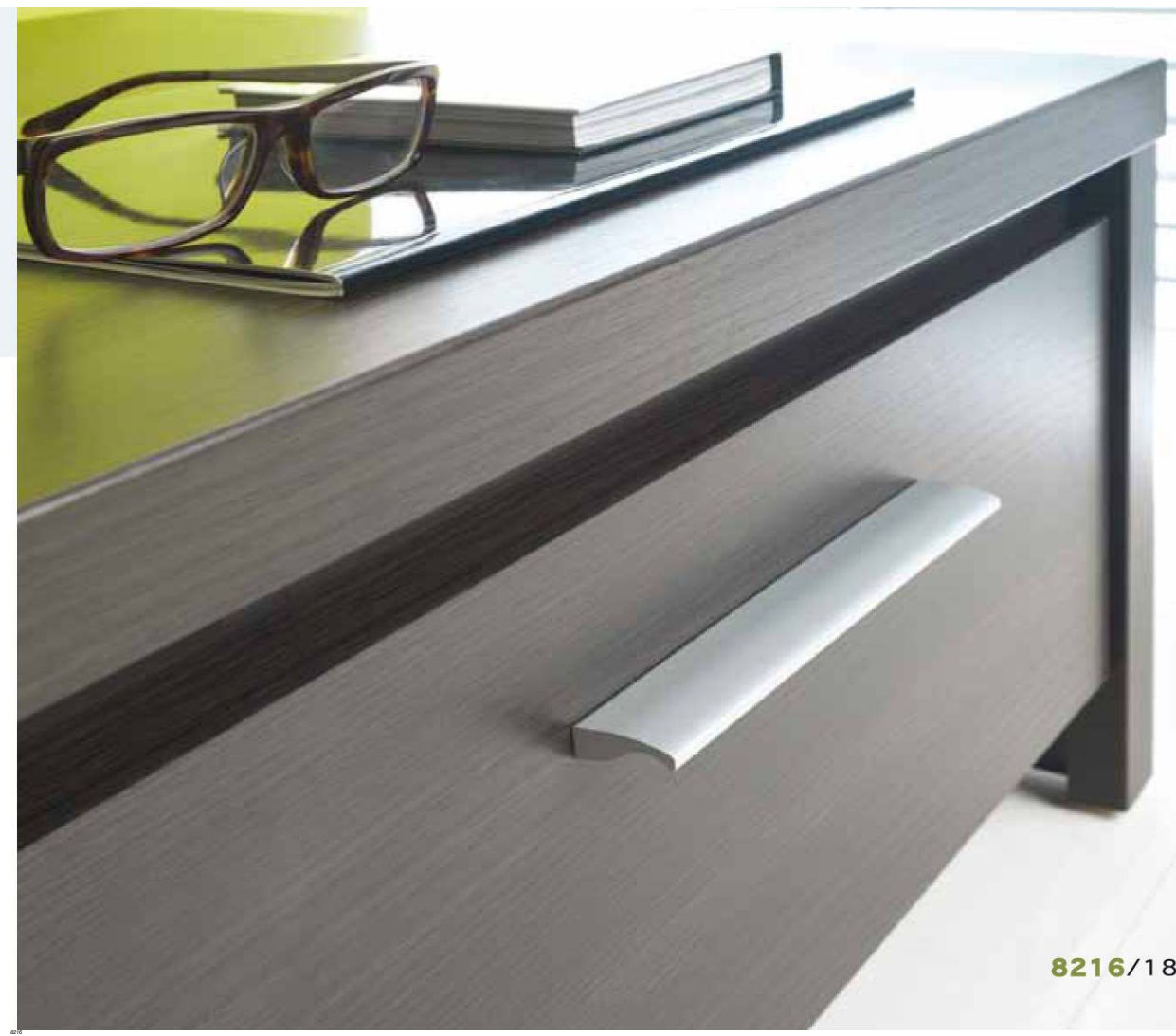

8216/180 MF18 DE



8217/105 CF1 DE



8217/105 MF2 DE



8217/105 CF5 DE



8217/105 MF13 DE



8217/105 MF18 DE

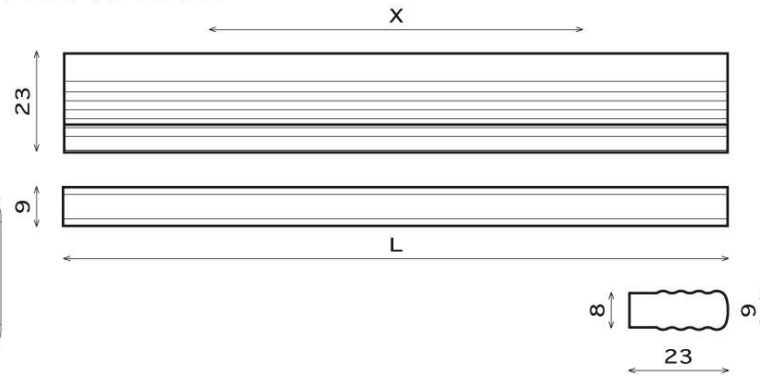

Art.Nr. item no	mm mm	Lochabstand drilling distance	Farbe colour
8217	100	64	unbegrenzte Farbvielfalt endless colour combination
	166	128	
	200	160	
	350	160x2	
	500	160x3	
(L) Length / (X) Drilling Distance		Upon Request	



8217/180 MF18 DE



8218/473 HF60 MV2 MV2



8218/473 MF18 MT1 MT1

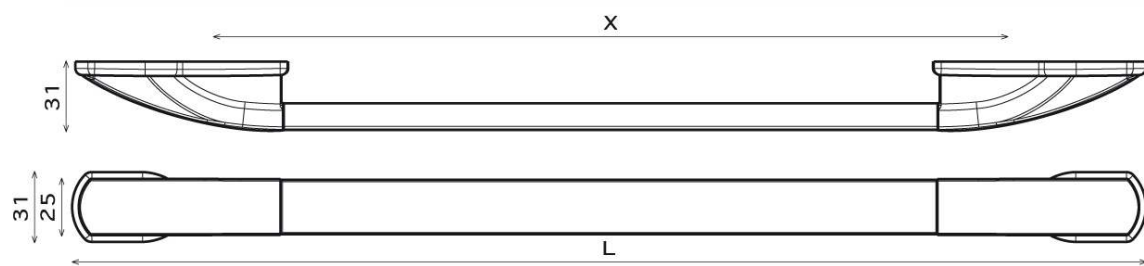

(insert M4)

Art.Nr. item no	mm mm	Lochabstand drilling distance	Farbe colour
8218	313 473 601	160 320 448	unbegrenzte Farbvielfalt endless colour combination
(L) Length / (X) Drilling Distance		Upon Request	



8218/473 MF18 MT1 MT1





8219/460 I MF2 DE CF1



8219/180 MF2 DE CF1



8219/180 MF2 DE CF5



8219/180 MF13 DE HF60



8219/180 MF13 DE CF1

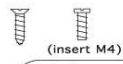
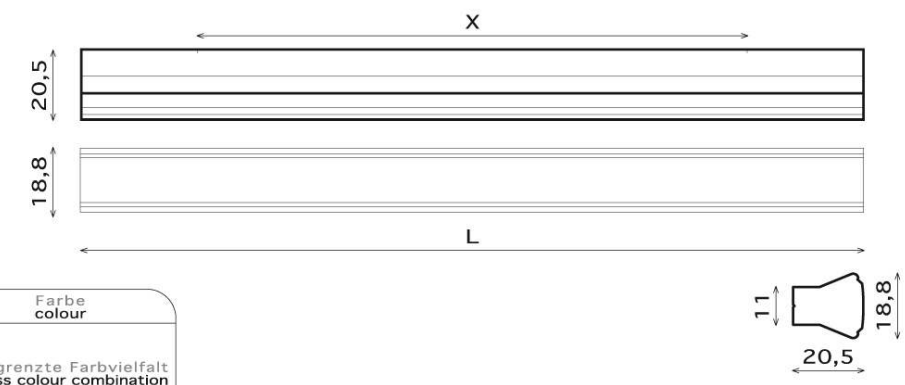

Art.Nr. item no	mm mm	Lochabstand drilling distance	Farbe colour
8219	100	64	unbegrenzte Farbvielfalt endless colour combination
	166	128	
	200	160	
	350	160x2	
	500	160x3	
(L) Length / (X) Drilling Distance			Upon Request

8219/473 I MF2 DE CF1





**8220B**/500 AG1 HF16



**8220A**/500 AG1 MF18



**8220B**/500 AG1 HF16



**8220A**/500 AG1 MF18

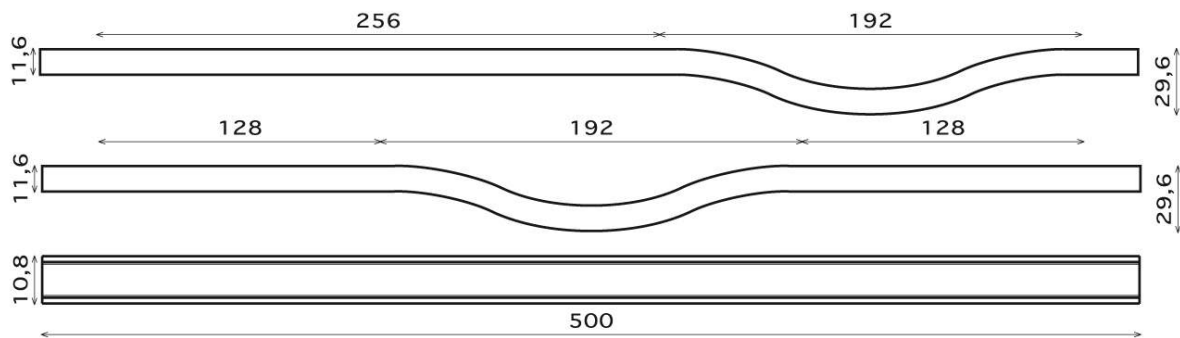

Art.Nr. item no	mm mm	Lochabstand drilling distance	Farbe colour
<b>8220A</b>	244	192	unbegrenzte Farbvielfalt endless colour combination
500	128,192,128		
<b>8220B</b>	436	192x2	
500	256,192		
(L) Length		Upon Request	



**8220A**/500 AG1 MF18



8221/90 GL36



8221/90 CP 195M



8221/90 MV2



8221/90 MT1

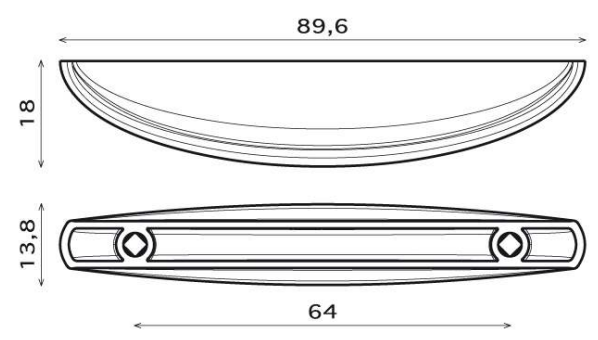

Art.Nr. item no	mm	Lochabstand drilling distance	Farbe colour
8221	90	64	unbegrenzte Farbvielfalt endless colour combination



8221/90 MV2





8222/182 | AC20 AC1



8222/182 | AC21 AC1



160

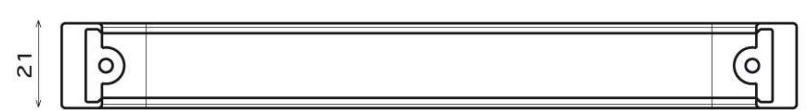

182



(insert M4)

Art.Nr. item no	mm mm	Lochabstand drilling distance	Farbe colour
8222	182	160	unbegrenzte Farbvielfalt endless colour combination



8222/182 | AC21 AC1



8223 GL41 AC19



8223 L7 AN5



8223 GL35 AC1



8223 GL35 AN5

unbegrenzte Farbvielfalt  
endless colour combination



8223/169 GL35 GL36



8223/169 MV2 AC1 MF2



8223/41 GL35 AC1



8223/169 GL35 AC1

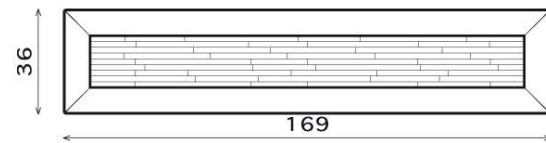
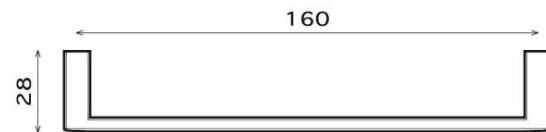
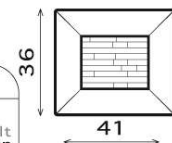
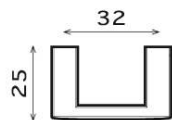

(insert M4)

Art.Nr. item no	mm	Lochabstand drilling distance	Farbe colour
8223	41	32	unbegrenzte Farbvielfalt endless colour combination
	169	160	

8223

32

160

78

design by **DESIGN**  
*Die Schreiber*



8223/169 MV2 AC1 MF2

79

8223

32

160

Contemporary

Contemporary