

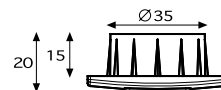

0001 / 46 MV2

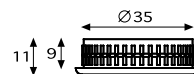

0003 / 35 MV2

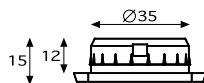
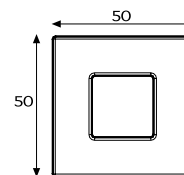
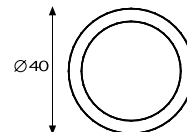
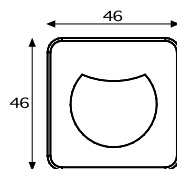

0001
0003
8078



Art.Nr. item no	Farbe colour
0001	unbegrenzte Farbvielfalt endless colour combination
0003	
8078	



8078/50 MV11



0001
0003
8078

8078/50 MV11



0009/24 MT1



0009/20 MT1



0009/24 MT3



0009/20 MT3

0009





0009 / 24 MT1

6000

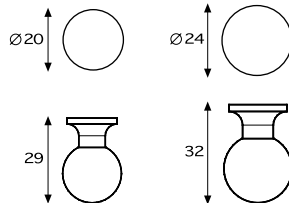

Art.Nr. item no	Farbe colour
0009	unbegrenzte Farbvielfalt endless colour combination



0028/30 I
MT3CP133M



0028/25 I
MT3CP133M



0028/30 I
MT1MV2



0028/25 I
MT1MV2

0028

| - insert





0028/30 | MT3CP133M

8200

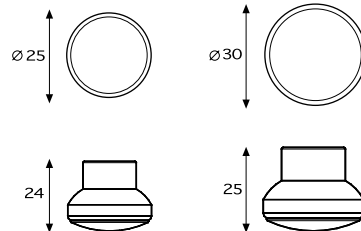

(insert M4)

Art.Nr. item no	Farbe colour
0028	unbegrenzte Farbvielfalt endless colour combination



0061/22 I MV2



0061/22 CP4G



0076/32 MV2MT1

| - insert



0061
0076

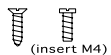

Art.Nr. item no	Farbe colour
0061	unbegrenzte Farbvielfalt
0076	endless colour combination

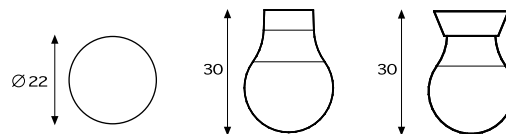



0076/32 CP4MMT3



0061
0076

0061/22 MV2



0065/32 | MT3T7



0065/32 | MV2MT1

| - insert



(insert M4)

Art.Nr. item no	Farbe colour
0065	unbegrenzte Farbvielfalt
8062	endless colour combination



8062/32 CP139G



0065/32 I MV2MT1

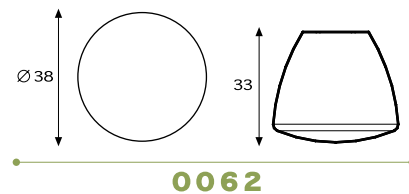
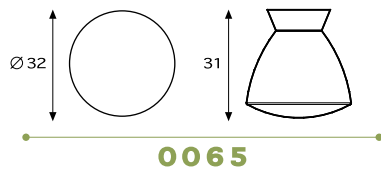

0065
8062



0385/40 MT1



0385/32 MV2





0385/32 MV2

0385

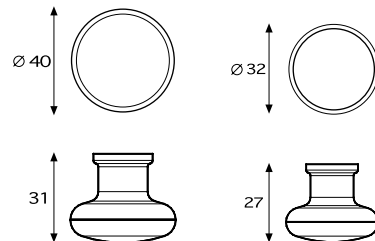

Art.Nr. item no	Farbe colour
0385	unbegrenzte Farbvielfalt endless colour combination



0391 / 34
I MV2CP4M



0391 / 28
I MV2CP4M



0391 / 34
MT1MV2



0391 / 28
MT1MV2

0391

I - insert

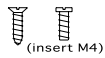
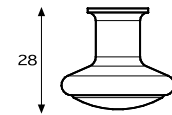
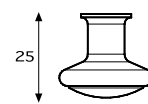
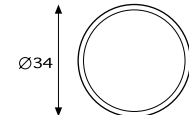
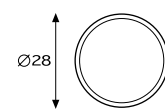

Art.Nr. item no	Farbe colour
0391	unbegrenzte Farbvielfalt endless colour combination



0391



0453/29 I H MT3



0453/25 H MT3

I - insert H - hollow

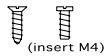

Art.Nr. item no	Farbe colour
0453	unbegrenzte Farbvielfalt endless colour combination



0453 / 29 H MV2

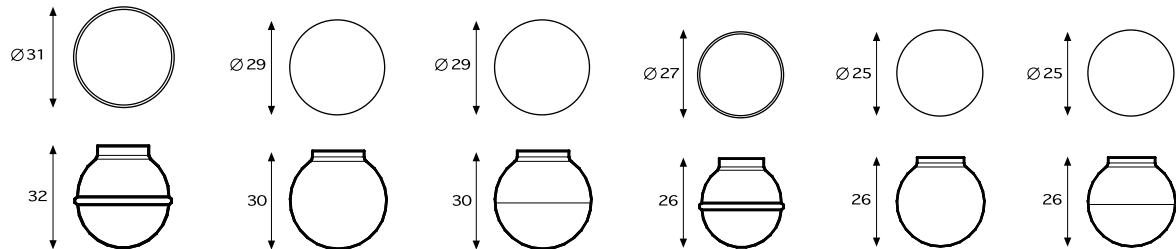



0609/44 | CP4GMT3



0609/44 | CP133MMV2

| - insert



0609

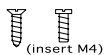

Art.Nr. item no	Farbe colour
0609	unbegrenzte Farbvielfalt endless colour combination

20

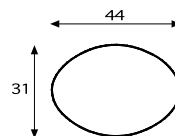



0609



0649



0649/36 I MT3CP103G



0649/36 MT1



0649/36 MV2CP4M

| - insert



Art.Nr. item no	mm mm	Lochabstand drilling distance	Farbe colour
0649	36	16	unbegrenzte Farbvielfalt endless colour combination



0649/36 MT3CP103G

0649

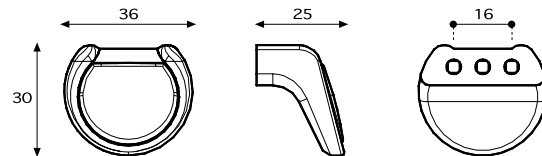



0769/83 CP133MMV2



0769/83 MT1MV11

GS-design

0769



Art.Nr. item no	mm mm	Lochabstand drilling distance	Farbe colour
0769	83	32	unbegrenzte Farbvielfalt endless colour combination



0769 / 83 MV2CP4G

0769

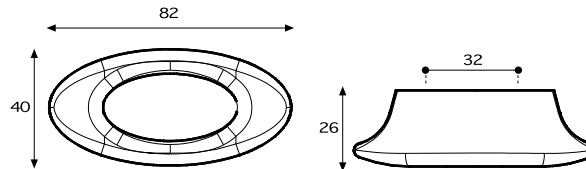

8006



8006/25 MT3



8006/25 MV2



Art.Nr. item no	Farbe colour
8006	unbegrenzte Farbvielfalt endless colour combination

26

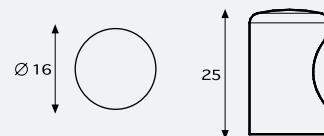



8006



8009/25 H MT3MT3



8009/25 H MT1MT1





8009/25 H MT3MT3

8008

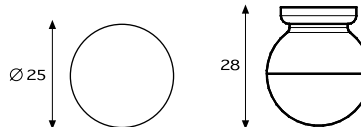

Art.Nr. item no	Farbe colour
8009	unbegrenzte Farbvielfalt endless colour combination



8015/36 H CP133MMV2



8015/36 H CP4GMT3



8015/31 H MV2



8015/25 H CP133MMV2



8015/25 H CP4GMT3



8015/22 H MV2

H - hollow

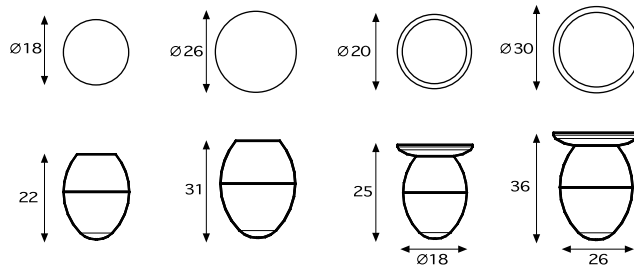

Art.Nr. item no	Farbe colour
8015	unbegrenzte Farbvielfalt endless colour combination



8015



8026/24 I MT3



8026/24 MT1



8026/24 MV2

| - insert



8026
8027

 **8026**
(insert M4)

 **8027**

Art.Nr. item no	Farbe colour
8026	unbegrenzte Farbvielfalt
8027	endless colour combination

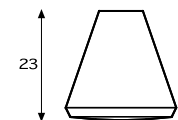
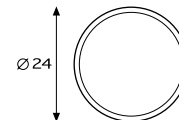



8027/26 MV2

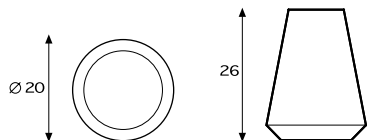

8026
8027

8026/24 MV2



8057/38 MT3MT3



8057/38 MT1MV2





8057/38 MT1MV2

8057

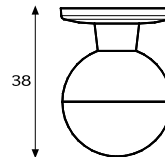
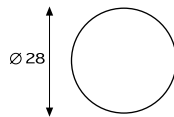

Art.Nr. item no	Farbe colour
8057	unbegrenzte Farbvielfalt endless colour combination



8066/36 I MT3



8066/36 MT1



8066/36 MV2

GS-design

8066

I - insert



Art.Nr. item no	Farbe colour
8066	unbegrenzte Farbvielfalt endless colour combination

36

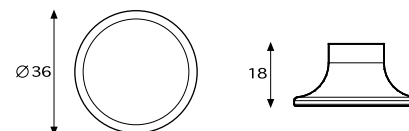



8066



8067/32 | CP133M



8067/32 | MV2

GS-design

8067

| - insert





8067/32 | CP133M

8067

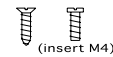
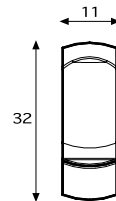

Art.Nr. item no	Farbe colour
8067	unbegrenzte Farbvielfalt endless colour combination



8085/32 I MV2SN1



8085/32 I MV11KGSA6

8085

I - insert





8085/32 I MV2SN1

8085

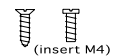
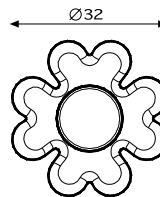
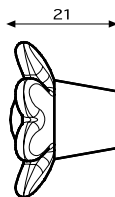

Art.Nr. item no	Farbe colour
8085	unbegrenzte Farbvielfalt endless colour combination



0024/34 | MT3



0024/28 | MT3



0024/34 | MT1



0024/28 | MT1

0024

| - insert



(insert M4)

Art.Nr. item no	Farbe colour
0024	unbegrenzte Farbvielfalt endless colour combination

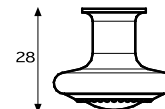
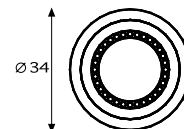
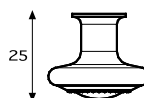
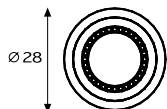



0024



0023/124 | MT3



0023/86 | MT1

I - insert



(insert M4)

Art.Nr. item no	mm	Lochabstand drilling distance	Farbe colour
0023	124	96	unbegrenzte Farbvielfalt endless colour combination
0023	86	64	



0023 / 124 | MT3

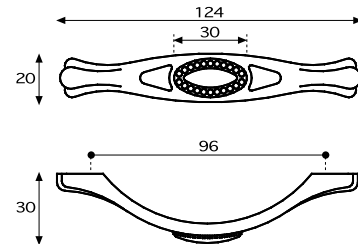
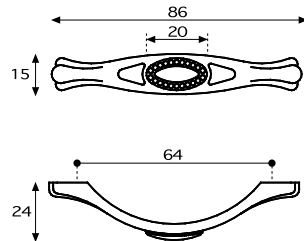

0023

64
96

0091



0091/63 I
MV2CP233M

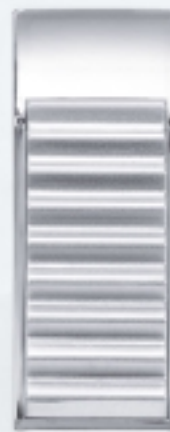

0091/63 I
MT1MV2

| - insert



(insert M4)

Art.Nr. item no	mm mm	Lochabstand drilling distance	Farbe colour
0091	63	16	unbegrenzte Farbvielfalt endless colour combination



0091 / 63 | MV2CP233M

0091

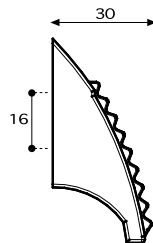
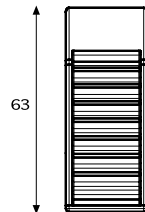



0092/52 MV2CP133M



0092/52 MT1MV2

0092





0092/52 MV2CP133M

2600

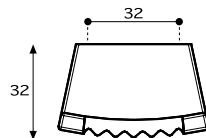

Art.Nr. item no	mm mm	Lochabstand drilling distance	Farbe colour
0092	52	32	unbegrenzte Farbvielfalt endless colour combination



0090 / 160 | MT1MV2

| - insert

0090



128



(insert M4)

50

Art.-Nr. item no	mm mm	Lochabstand drilling distance	Farbe colour
0090	160	128	unbegrenzte Farbvielfalt endless colour combination

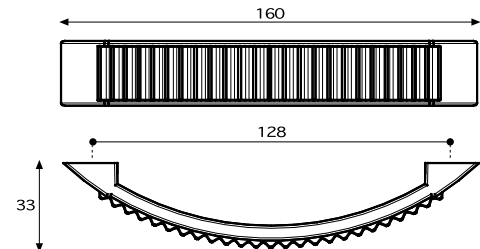

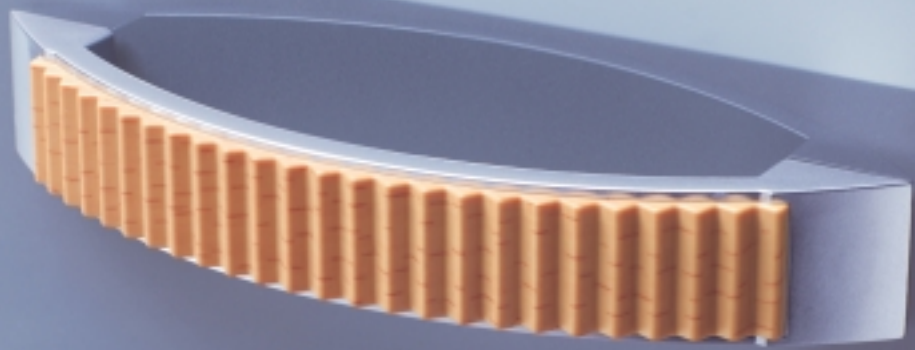

0090

128



0095 / 42 MV 2

0095





0095 / 42 MV 2

0095

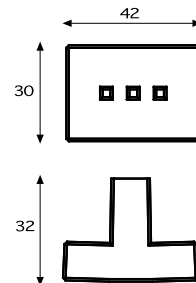

Art.Nr. item no	Farbe colour
0095	unbegrenzte Farbvielfalt endless colour combination



0094/170 MV2



0094/140 MV2



0094

128

160



Art.Nr. item no	mm mm	Lochabstand drilling distance	Farbe colour
0094	140	128	unbegrenzte Farbvielfalt endless colour combination
0094	172	160	

54

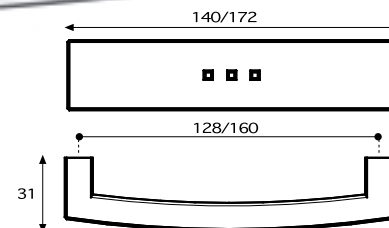



0094

128

160



0873/341 | MT1



0873/281 | MV2



0873/341 | CP133M



0873/281 | CP123M

0873

| - insert





0873/281 MV2

0873

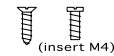
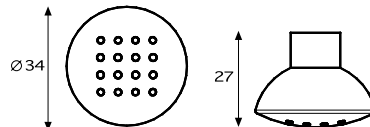
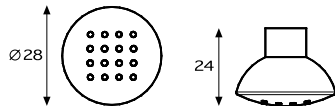

Art.Nr. item no	Farbe colour
0873	unbegrenzte Farbvielfalt endless colour combination



0083/170 I MT1



0083/137 I CP123M

| - insert



0083
€800
0097

96

128



0097/170 | MV2MT1

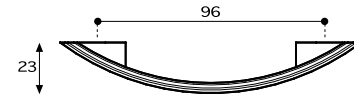
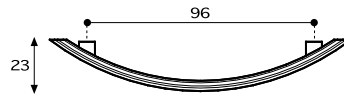
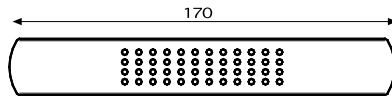
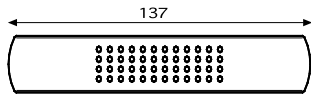

0083

0097

Art.Nr. item no	mm mm	Lochabstand drilling distance	Farbe colour
0083	137	96	unbegrenzte Farbvielfalt endless colour combination
0083	170	128	
0097	137	96	
0097	170	128	



**0083
1600
0097**

96

128

8045



8045/36 I MV2



8045/36 CP133M

I - insert

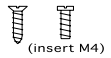

60

Art.Nr. item no	Farbe colour
8045	unbegrenzte Farbvielfalt endless colour combination

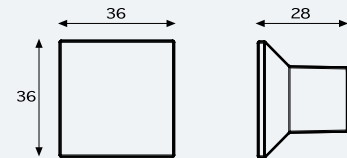



8045

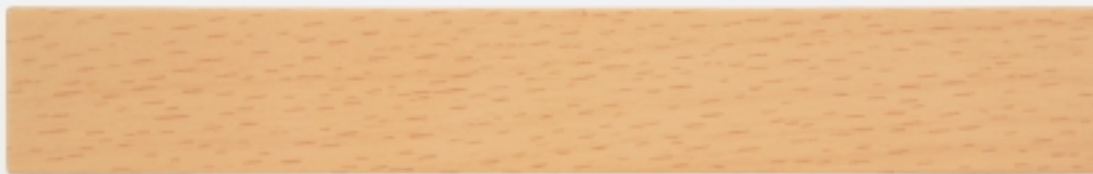

8004/164 CP133M



8004/164 MV2

8004



128



8004 / 164 MV2



8004

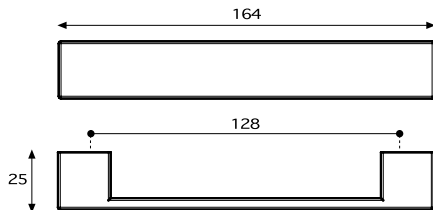

Art.Nr. item no	mm mm	Lochabstand drilling distance	Farbe colour
8004	164	128	unbegrenzte Farbvielfalt endless colour combination

128

63



8076/15 MV2



8076/15 MV11



8076



Art.Nr. item no	Farbe colour
8076	unbegrenzte Farbvielfalt endless colour combination

64

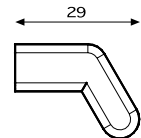
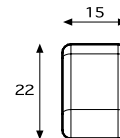



8076

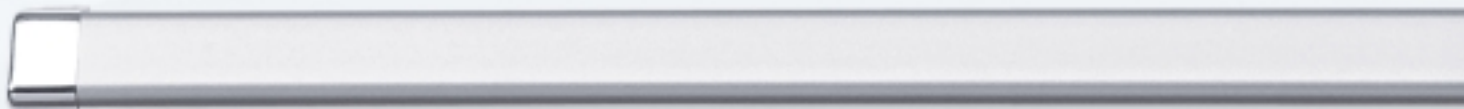

8017/271 MF18MT1

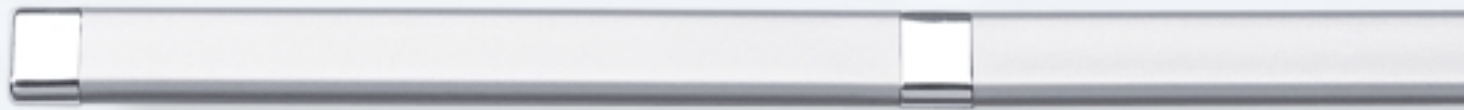

8017/271 T MF18MT1



Art.Nr. item no	mm mm	Lochabstand drilling distance	Farbe colour
8017	783 T	384 x 2	unbegrenzte Farbvielfalt endless colour combination
8017	655 T	320 x 2	
8017	527 T	256 x 2	
8017	399 T	192 x 2	
8017	399	384	
8017	335	320	
8017	271 T	128 x 2	
8017	271	256	
8017	207	192	
8017	143	128	

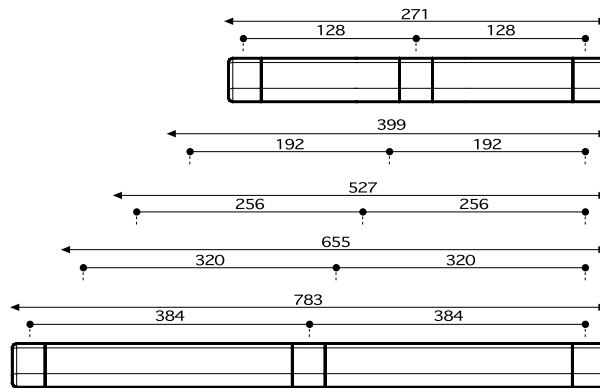

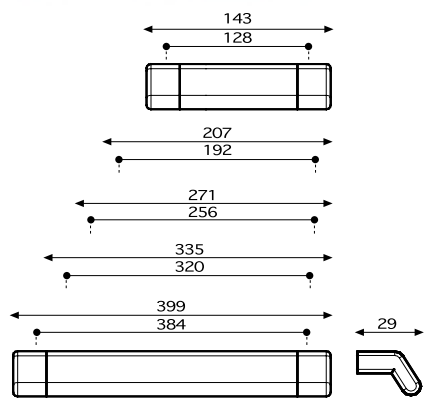
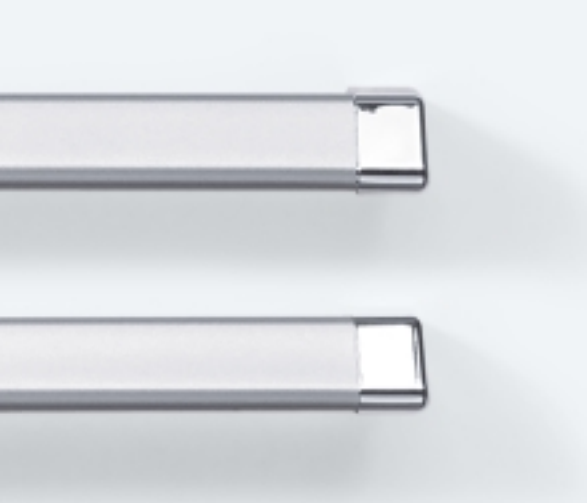

8017

128

L

8017/207 MF18MT1

67



8099/40 | MV2SN1



8099/40 | MV11KGSA6



8099/40 | MV11SNT3

| - insert





8099/40 I MV11KGS A6

8099

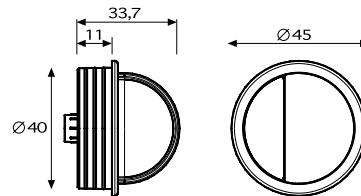



(insert M4)

Art.Nr. item no	Farbe colour
8099	unbegrenzte Farbvielfalt endless colour combination

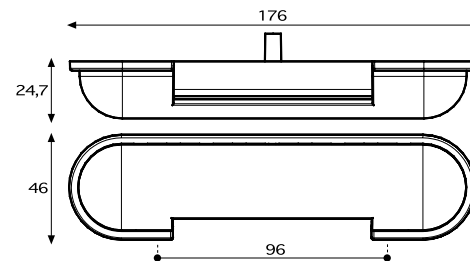

8100/176 MV11SN1



Art.Nr. item no	mm mm	Lochabstand drilling distance	Farbe colour
8100	176	96	unbegrenzte Farbvielfalt endless colour combination

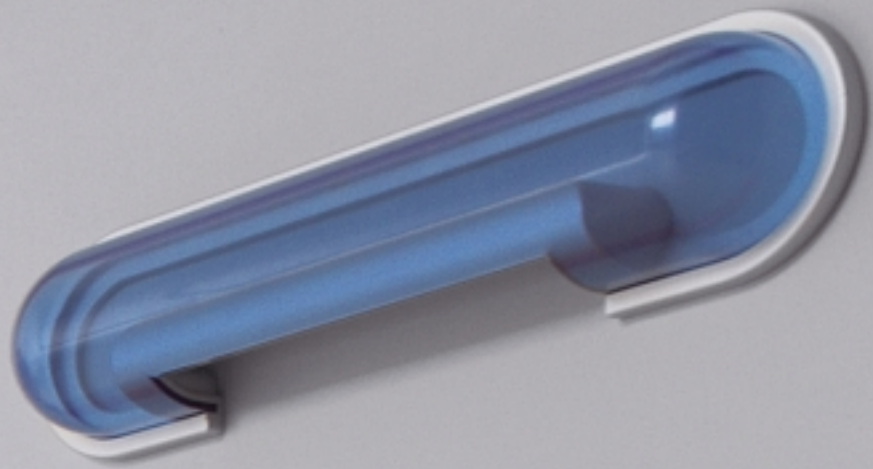

8100

96

8100/176 MV11KGSA6

71



8104/40 MT1MV2



8104/40 MV11CP195M

GS-design

8104



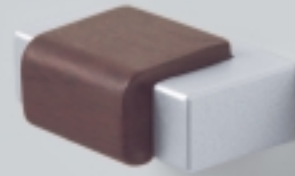

8104/40 MV11CP195M

8104

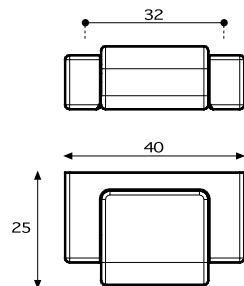

Art.Nr. item no	Farbe colour
8104	unbegrenzte Farbvielfalt endless colour combination

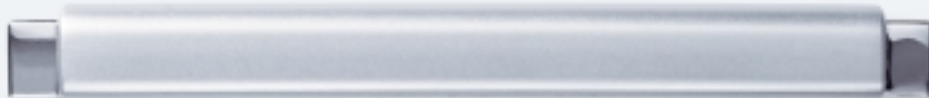

8103/136 MT1MV2



8103/136 MV11CP195M

GS-design

8103



128



Art.Nr. item no	mm mm	Lochabstand drilling distance	Farbe colour
8103	136	128	unbegrenzte Farbvielfalt endless colour combination

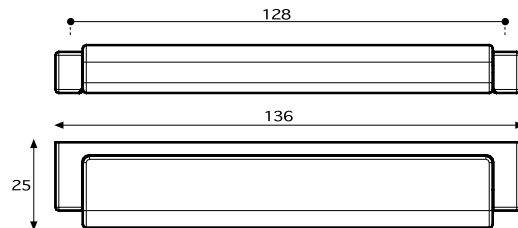



8103

128

8103/136 MV11CP195M

75



0039/124 MT1MV2



0039/100 I MT3MV3

| - insert



 
(insert M4)

Art.Nr. item no	mm mm	Lochabstand drilling distance	Farbe colour
0039	100	64	unbegrenzte Farbvielfalt endless colour combination
0039	124	96	



0039 / 124 MT1MV2

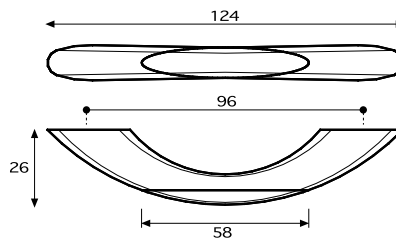
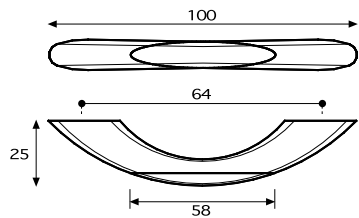

0039

64
96



0043/124 MV2SNT6



0043/90 I MV2CP133M

I - insert



0043

64

96

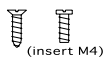

Art.Nr. item no	mm mm	Lochabstand drilling distance	Farbe colour
0043	90	64	unbegrenzte Farbvielfalt
0043	124	96	endless colour combination



0043 / 124 MT1MV2



0043

64

96

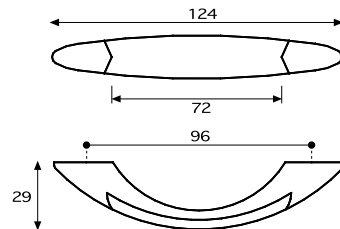
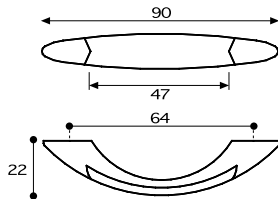



0050/137 MT3



0080/137 MV2MT1

| - insert

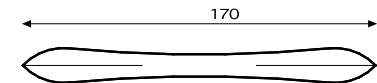
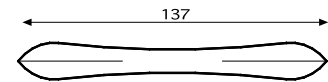
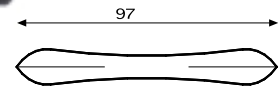

0050
0080

64

96

128



Art.Nr. item no	mm	Lochabstand drilling distance	Farbe colour
0050	97	64	unbegrenzte Farbvielfalt endless colour combination
0050	137	96	
0050	170	128	
0080	142	96	
0080	175	128	

80

0050



0050 / 137 MT3

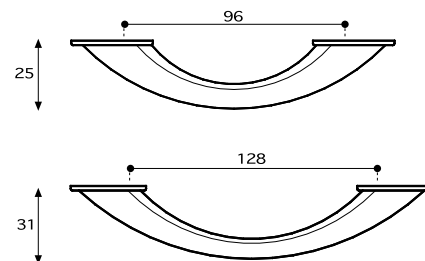
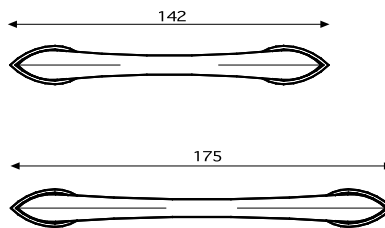
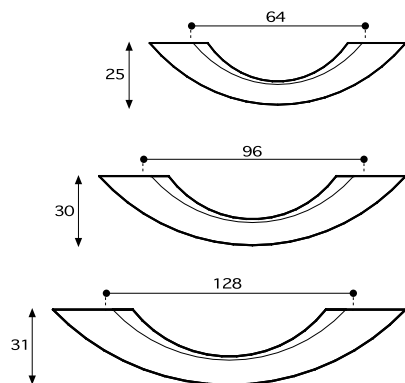

0080

0050
0080

64
96
128



0071 / 170 | CP4GMT3



0064 / 137 | CP133M

| - insert



0064
0071

96

128



0064/170 | MV2

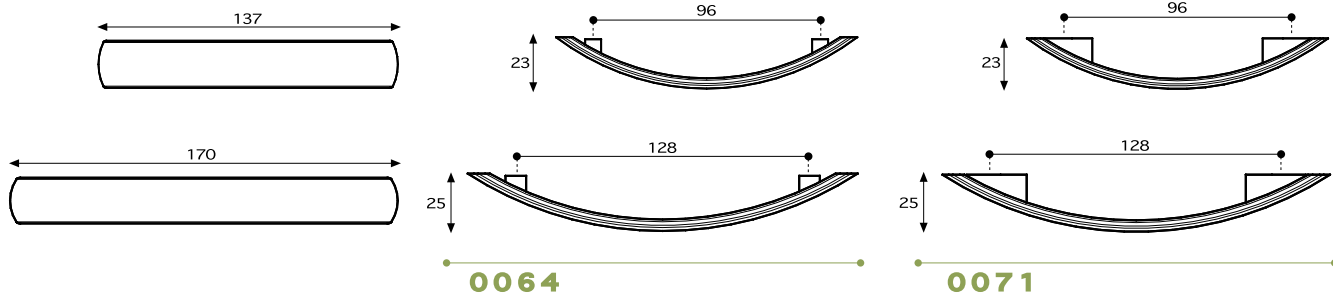

Art.Nr. item no	mm mm	Lochabstand drilling distance	Farbe colour
0064	137	96	unbegrenzte Farbvielfalt endless colour combination
0064	170	128	
0071	137	96	
0071	170	128	



0064
0071

96
128

0070



0070/100 MV2

0070/100 MT3



Art.Nr. item no	mm mm	Lochabstand drilling distance	Farbe colour
0070	100	16	unbegrenzte Farbvielfalt endless colour combination

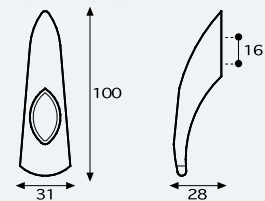



0070

0070/100 CP4G



0089 / 144 CP4GMT3

6800



128



0089 / 144 MV2MT1



6800

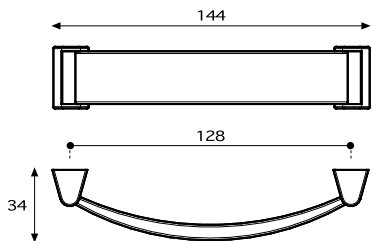

Art.Nr. item no	mm mm	Lochabstand drilling distance	Farbe colour
0089	144	128	unbegrenzte Farbvielfalt endless colour combination

128

87



0093/170 CP4G



0093/140 MV2



Art.Nr. item no	mm mm	Lochabstand drilling distance	Farbe colour
0093	142	128	unbegrenzte Farbvielfalt
0093	174	160	endless colour combination

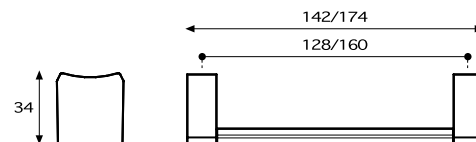



0093

128

160



0096/175 MV2MT1



0096/145 CP4MMV2



128

160



Art.Nr. item no	mm mm	Lochabstand drilling distance	Farbe colour
0096	145	128	unbegrenzte Farbvielfalt endless colour combination
0096	175	160	

90

9600



0096 / 145 MV2MT1



9600

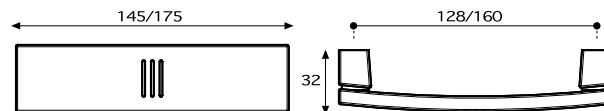

128
160



0099/180 CP4GMT3



0099/180 MV2T7

0099



128



0099 / 180 MV2T7



6600

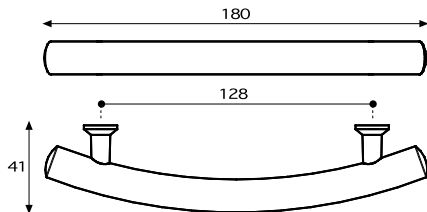

Art.Nr. item no	mm mm	Lochabstand drilling distance	Farbe colour
0099	180	128	unbegrenzte Farbvielfalt endless colour combination

128

93



0287/106 MT3



0287/106 MT1



0287/73 MV2

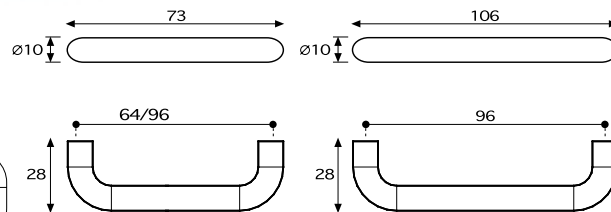

0287

64

96



Art.Nr. item no	mm mm	Lochabstand drilling distance	Farbe colour
0287	73	64	unbegrenzte Farbvielfalt endless colour combination
0287	106	96	



0287

64
96



0549 / 134 MV2



0549 / 97 MT1



0549

64

96



Art.Nr. item no	mm mm	Lochabstand drilling distance	Farbe colour
0549	97	64	unbegrenzte Farbvielfalt endless colour combination
0549	134	96	



0549 / 134 MV2



0549

64
96

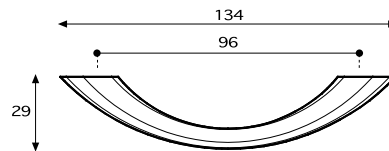
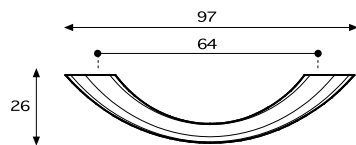



0570/128 CP4MMT3

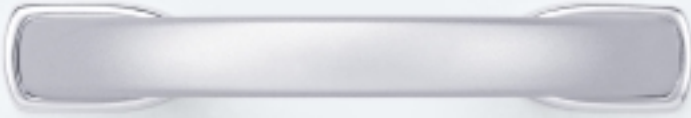

0570/90 I MV11MT1

| - insert



0563
0570

64

96



Art.Nr. item no	mm mm	Lochabstand drilling distance	Farbe colour
0563	86	64	unbegrenzte Farbvielfalt endless colour combination
0563	124	96	
0570	90	64	
0570	128	96	

98

0570

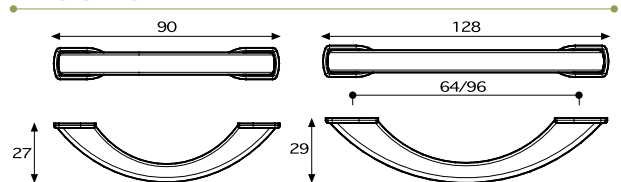



0563/124 | MT1



0563/86 | MV2

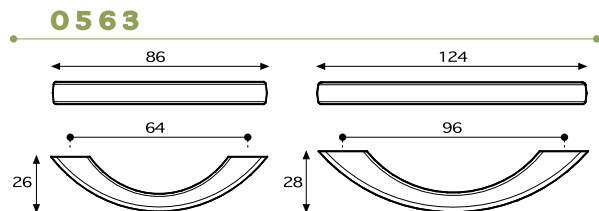

0563
0570

64
96

0570/90 | MV11MT1



0592/124 | MT3CP4G



0592/86 | MV2CP4M



0592

64

96

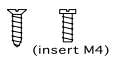

(insert M4)

Art.Nr. item no	mm mm	Lochabstand drilling distance	Farbe colour
0592	86	64	unbegrenzte Farbvielfalt
0592	124	96	endless colour combination

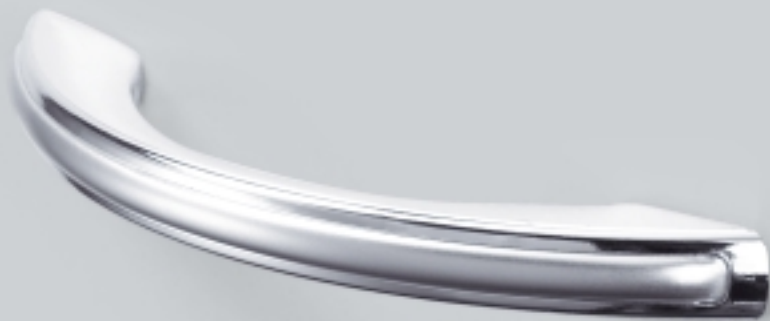

0592 / 124 | MT1MV2

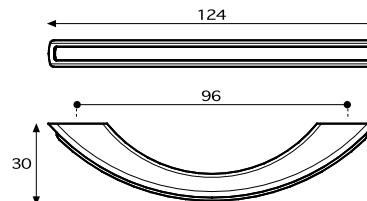
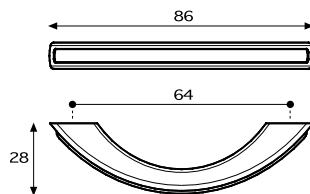

0592

64
96



8003/77 MV11



8003/77 MT1



8003/77 MT3

8003

64

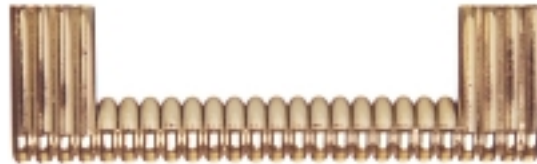

(insert M4)

Art.Nr. item no	mm mm	Lochabstand drilling distance	Farbe colour
8003	77	64	unbegrenzte Farbvielefalt endless colour combination

102

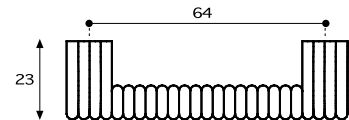
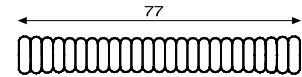



8003

64



8007/168 MT3



8007/168 MV2

8007



128



8007 / 168 CP4G



8007

128

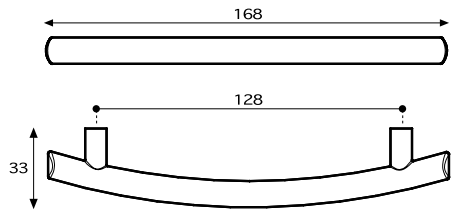

Art.Nr. item no	mm mm	Lochabstand drilling distance	Farbe colour
8007	168	128	unbegrenzte Farbvielfalt endless colour combination



8010/148 | MV2



8010/148 | CP133M

| - insert



8010

96



(insert M4)

Art.Nr. item no	mm mm	Lochabstand drilling distance	Farbe colour
8010	148	96	unbegrenzte Farbvielfalt endless colour combination

106

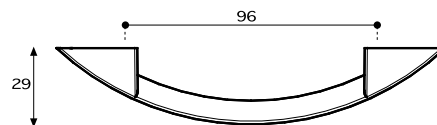
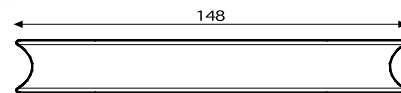



8010

96



8011/110 | MV2



8011/110 | MV1

| - insert

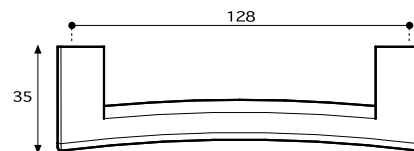
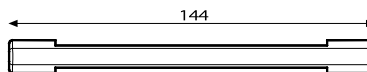
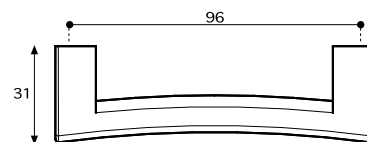
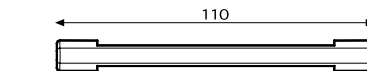

8011

96

128

 (insert M4)

Art.Nr. item no	mm mm	Lochabstand drilling distance	Farbe colour
8011	110	96	unbegrenzte Farbvielfalt endless colour combination
8011	144	128	

108



8011

96

128

8011 / 110 | MV1



8046/148 | MV2CP133M



8013/148 | MT3CP4M

| - insert



8013
8046

128



8046 / 148 | MT1MV2

8013
8046

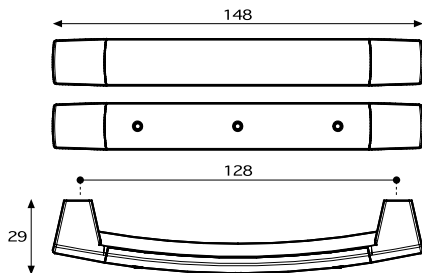

(insert M4)

Art.Nr. item no	mm mm	Lochabstand drilling distance	Farbe colour
8013	148	128	unbegrenzte Farbvialfalt
8046	148	128	endless colour combination

128



8014/184 | CP133M



8014/184 | MV2

8014

| - insert



128

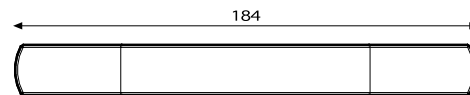

(insert M4)

Art.-Nr. item no	mm mm	Lochabstand drilling distance	Farbe colour
8014	184	128	unbegrenzte Farbvielfalt endless colour combination

112



8014

128

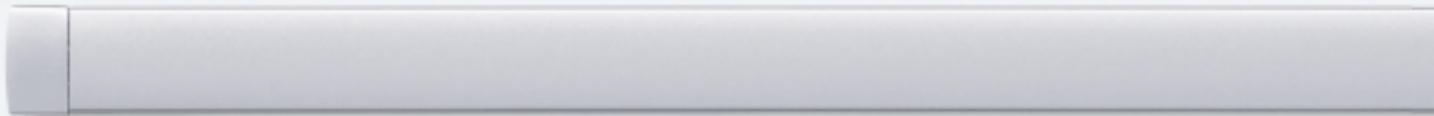

8016/397 MF18MV2

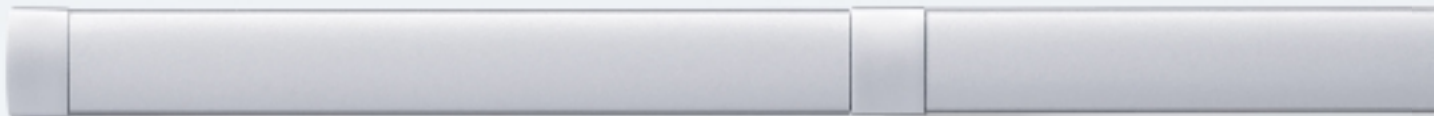

8016/397 T MF18MV2

8016



Art.Nr. item no	mm mm	Lochabstand drilling distance	Farbe colour
8016	781 T	384 x 2	unbegrenzte Farbvielfalt endless colour combination
8016	653 T	320 x 2	
8016	525 T	256 x 2	
8016	397 T	192 x 2	
8016	397	384	
8016	333	320	
8016	269 T	128 x 2	
8016	269	256	
8016	205	192	
8016	141	128	

128

L

114

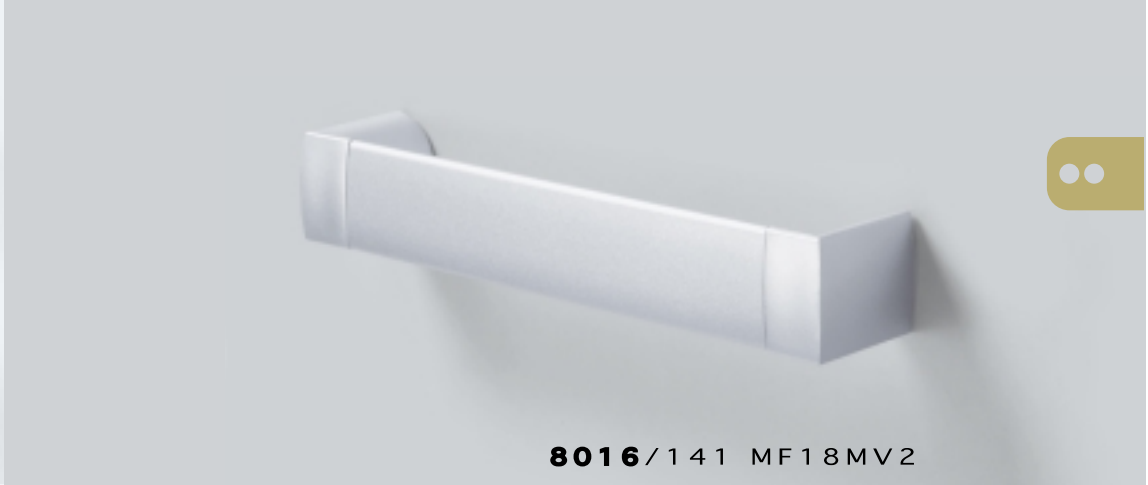

8016 / 141 MF18MV2

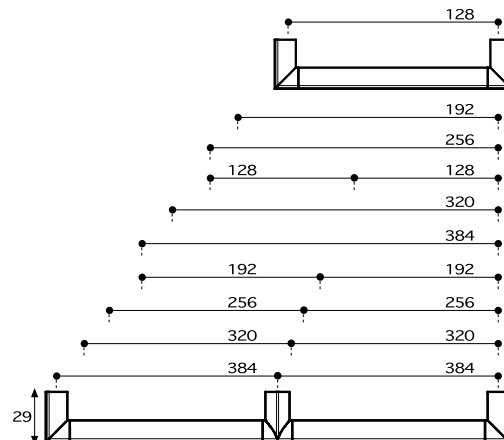
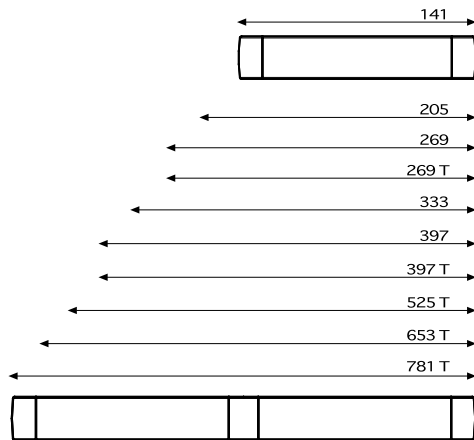

8016

128

L

115

••



8018/202 MV2MT1



8018/138 L7MT3

8018



128

L

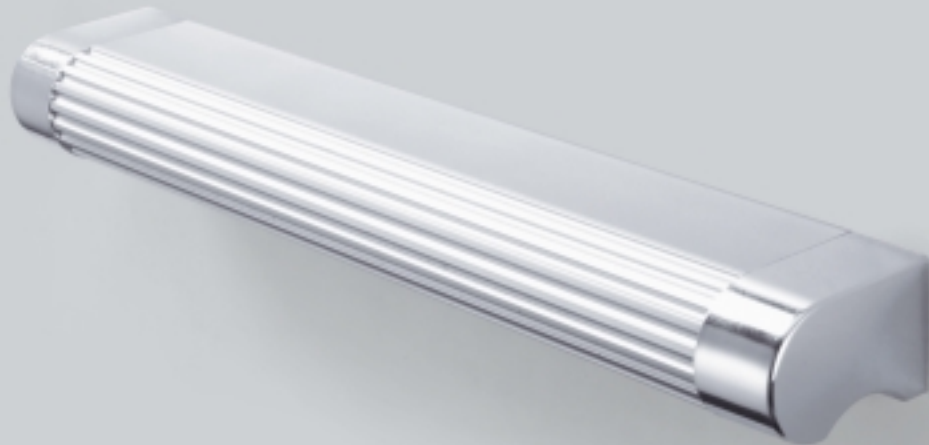

8018/138 MV2MT1

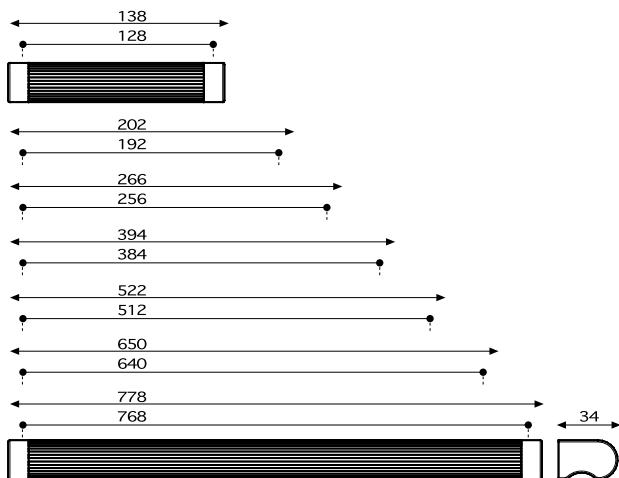

Art.Nr. item no	mm mm	Lochabstand drilling distance	Farbe colour
8018	778	768	unbegrenzte Farbvielfalt endless colour combination
8018	650	640	
8018	522	512	
8018	394	384	
8018	202	192	
8018	138	128	



8018

128

L



8097/324 CP133M



8021/130 I MV2

I - insert



8021
8096
8097

96

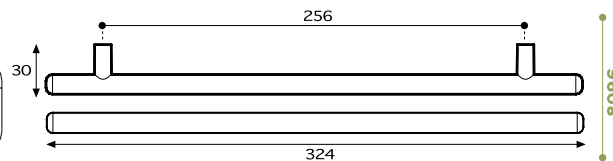
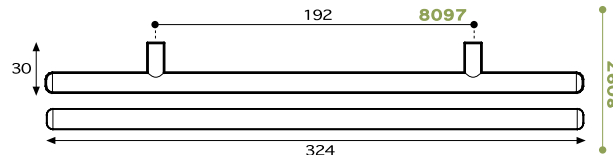
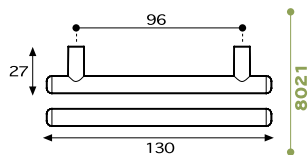

L

Art.Nr. item no	mm mm	Lochabstand drilling distance	Farbe colour
8021	130	96	unbegrenzte Farbvielfalt endless colour combination
8097	324	192	
8096	324	256	

118



8021
8606
8096
8097

96

L

8097 / 324 MV2

119



8047/148 | MT3AN5



8047/148 | T7AN3

| - insert



8047

128



Art.Nr. item no	mm mm	Lochabstand drilling distance	Farbe colour
8047	148	128	unbegrenzte Farbvielefalt endless colour combination

120

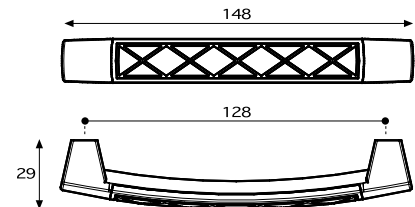



8047

128



8059/240 | CP133M

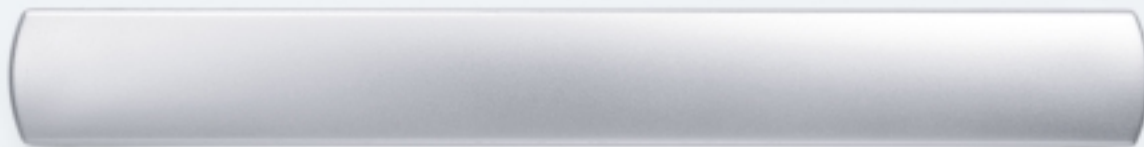

8059/176 | MV11

| - insert



8059

160

L



Art. Nr. item no	mm mm	Lochabstand drilling distance	Farbe colour
8059	176	160	unbegrenzte Farbielfalt
8059	240	224	endless colour combination

122

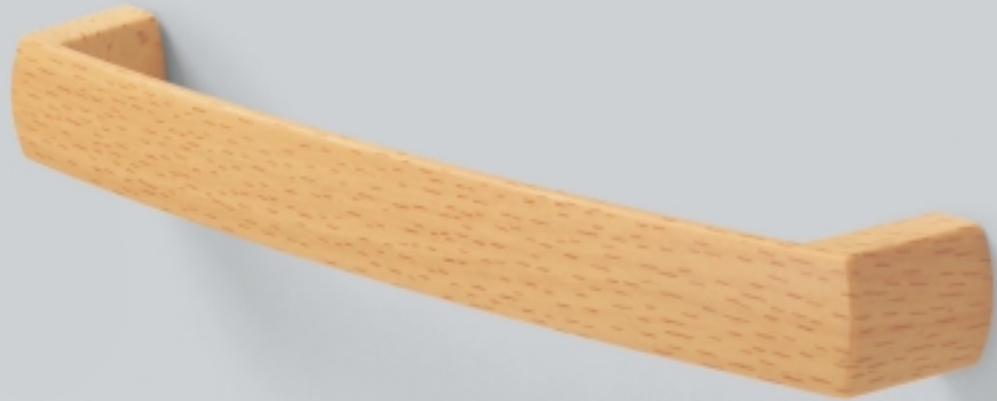

8059/176 | CP133M



8059

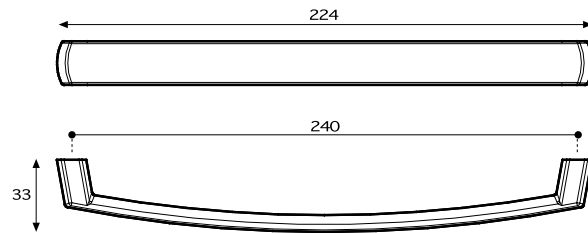
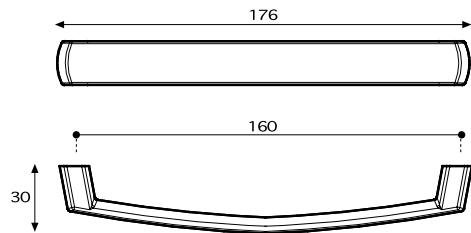

160
L



8063/127 | MV11SNT8



8063/127 | MV11CP4M

| - insert

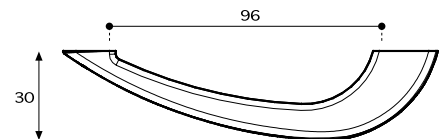
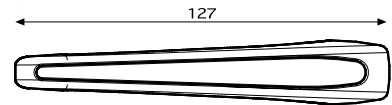

8063

96



Art.Nr. item no	mm mm	Lochabstand drilling distance	Farbe colour
8063	127	96	unbegrenzte Farbvielfalt endless colour combination

124



8063

96



8064 / 152 I MV2

| - insert



8064

128

126

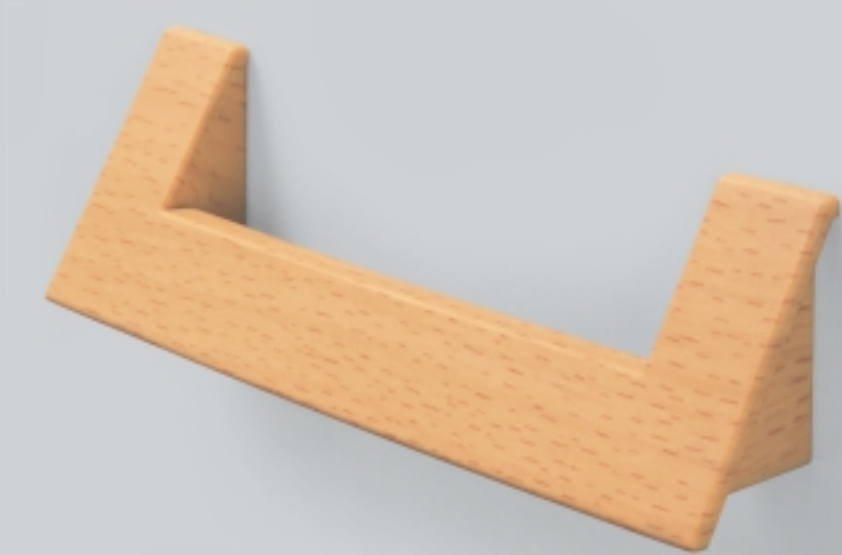

8064/152 | CP133M



8064

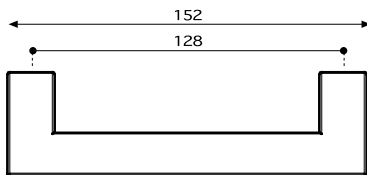

Art.Nr. item no	mm mm	Lochabstand drilling distance	Farbe colour
8064	152	128	unbegrenzte Farbvielfalt endless colour combination

128

127



8065

128



8065/137 I MV2SNT3



8065/137 I MV2MV2



8065/137 I MV2CP133M

| - insert

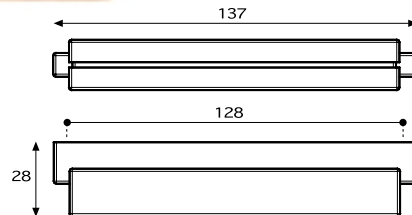

(insert M4)

Art.Nr. item no	mm mm	Lochabstand drilling distance	Farbe colour
8065	137	128	unbegrenzte Farbvielfalt endless colour combination

128



8065

128

8065 / 137 | MV2CP133M

129



8080/124 | MV2AN5



8080/124 | MV2AN2

| - insert





8080/124 I MV2AN5



8080

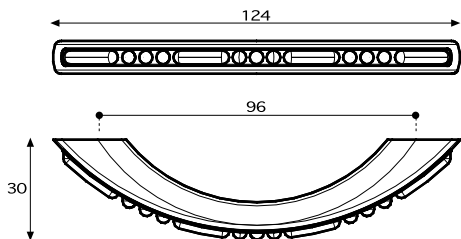

 (insert M4)

Art.Nr. item no	mm mm	Lochabstand drilling distance	Farbe colour
8080	124	96	unbegrenzte Farbvielfalt endless colour combination

96



8091 / 164 | SN 1

8091

| - insert



128



Art.Nr. item no	mm mm	Lochabstand drilling distance	Farbe colour
8091	164	128	unbegrenzte Farbvielfalt endless colour combination

132



8091 / 164 | SN1



8091

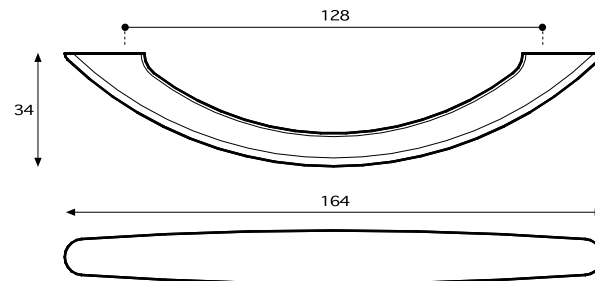

128

133



8092 / 136 | MV11CP130M

GS-design

8092

| - insert



96

 (insert M4)

Art.Nr. item no	mm mm	Lochabstand drilling distance	Farbe colour
8092	136	96	unbegrenzte Farbvielfalt endless colour combination



8092/136 | MV11CP130M

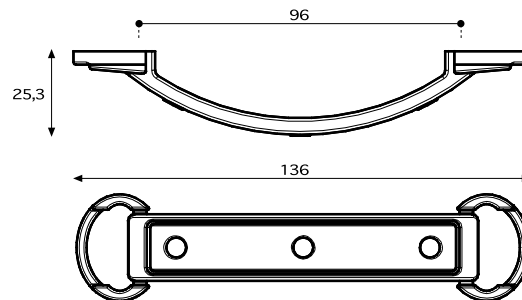

8092

96

135



8094/146 T7MV2



8094/146 I MV7CP130M

I - insert



8094

96

128



Art.Nr. item no	mm mm	Lochabstand drilling distance	Farbe colour
8094	146	96	unbegrenzte Farbvielfalt endless colour combination
8094	146	128	

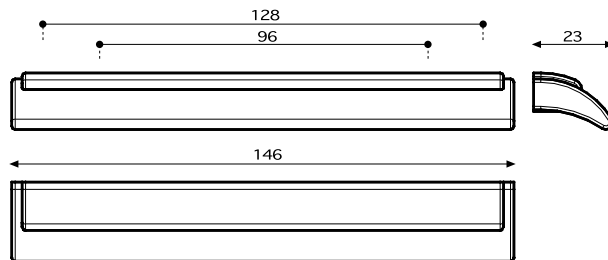



8094

96

128

8094/146 MV7CP130M

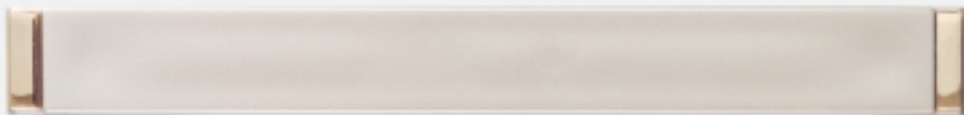

8105/142 MV7MT3



8105/142 I CP100G

GS-design

I - insert

8105



128



Art.Nr. item no	mm mm	Lochabstand drilling distance	Farbe colour
8105	144	128	unbegrenzte Farbvielfalt endless colour combination

138



8105 / 142 MV7MT3



8105

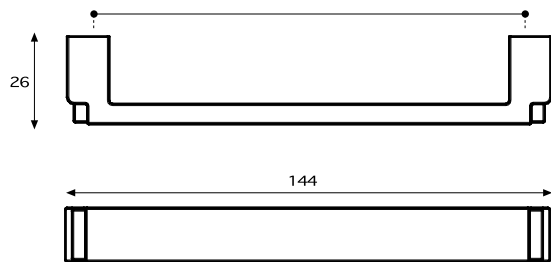

128



8106/168 CP103GMT3



8106/168 I MV2T7

GS-design

I - insert

8106



128



Art.Nr. item no	mm mm	Lochabstand drilling distance	Farbe colour
8106	168	128	unbegrenzte Farbvielfalt endless colour combination

140



8106/168 CP103GMT3



8106

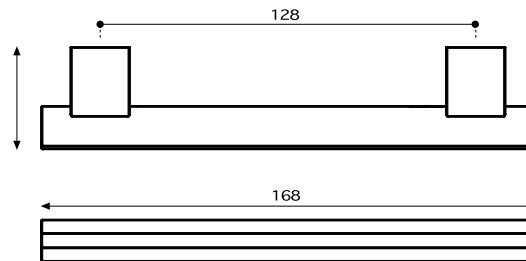

128

141



SA59/156 | CP4M



SA59/156 | MV2

| - insert



SA59

96



(insert M4)

Art.Nr. item no	mm mm	Lochabstand drilling distance	Farbe colour
SA59	156	96	unbegrenzte Farbvielfalt endless colour combination



SA59 / 156 | CP133M



SA59

96

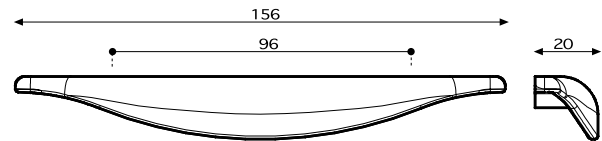



0021 MT3DF1



0087/57 MV2



0417/52 MV2

0021
0087
0088

0416
0417
0086

Art.Nr. item no	mm mm	Lochabstand drilling distance	Farbe colour
0021	84	20	unbegrenzte Farbvielfalt endless colour combination
0086	585	—	
0087	56	20	
0088	135	20	
0416	137	20	
0417	62	20	

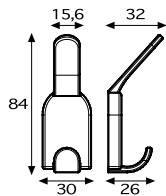

0021

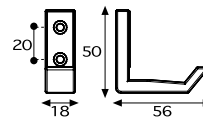

0087

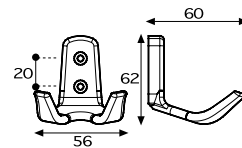

0417



0416/150 MV2



0088/134 MV2



0086/585 K1

0021
0087
0088

0416
0417
0086

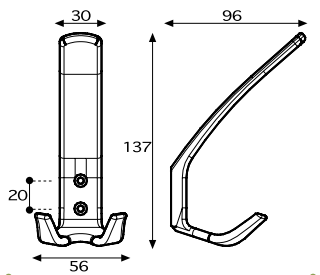

0416

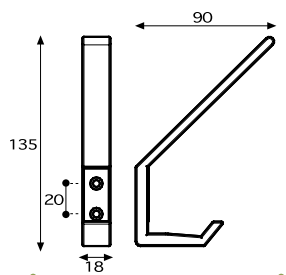

0088

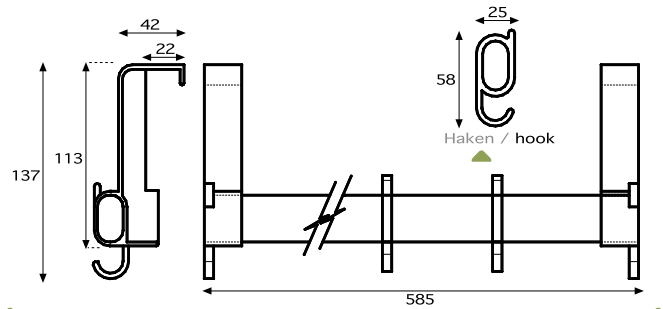

0086

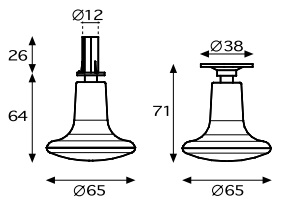

0012

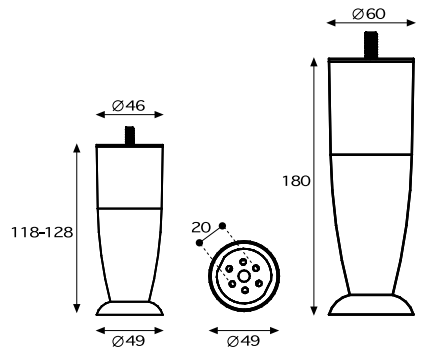

0082



0012/65 B MV2K10

0012
0082

Art.Nr. item no	Farbe colour
0012	unbegrenzte Farbvielfalt
0082	endless colour combination



0082/118 MV2



0082/180 MV2

0012
0082

8022 0719
8081 0763



GS-design

0719/54 CP4GMV2



GS-design

0763/70 MV2MT1

Art.-Nr. item no	Farbe colour
0719 0763 8022 8081	unbegrenzte Farbvielfalt endless colour combination

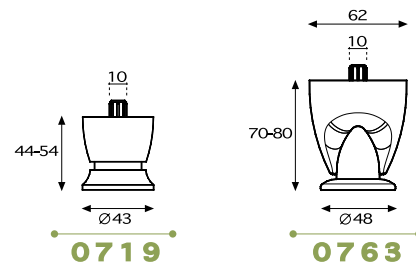



8022 / 46 CP133M



8081 / 64 AN2

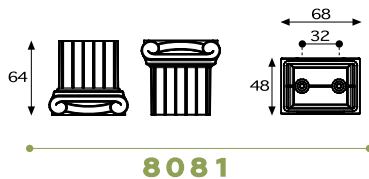
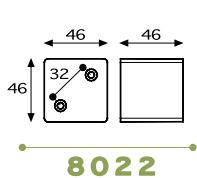

8022 0719
8081 0763



0066
0927
0098



0066/100 MV2



0927/145 MV11

Art.Nr. item no	Farbe colour
0066	unbegrenzte Farbvielfalt endless colour combination
0927	
0098	

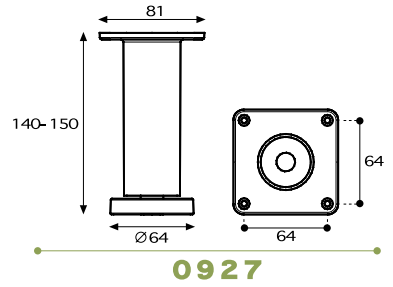
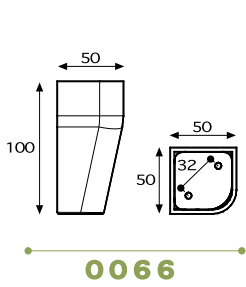



0098/72 MV2

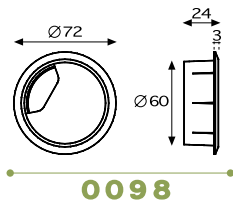

0066
0927
0098

8023
8054
8055



8054/60 MV2

Art.Nr. item no	Farbe colour
0098	
8023	unbegrenzte Farbvielfalt
8055	endless colour combination

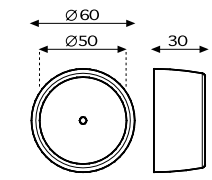

8054

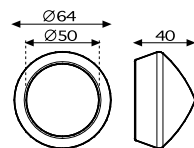

8055

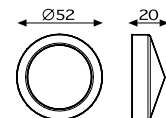

8023



8055/64 MV2



8023/52 MV11



8023
8054
8055



0051/60 MV2

0052/50 MV2



**0051
0052
8031**

Art.Nr. item no	Farbe colour
0051	unbegrenzte Farbvielfalt endless colour combination
0052	
8031	

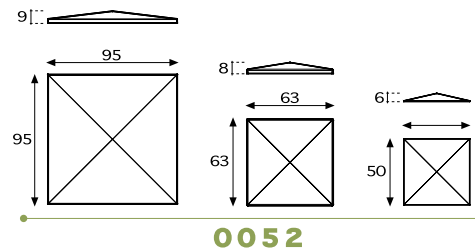
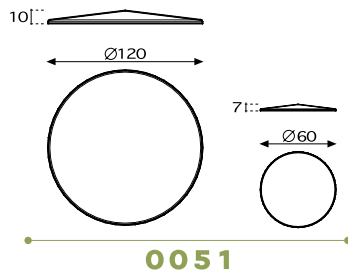

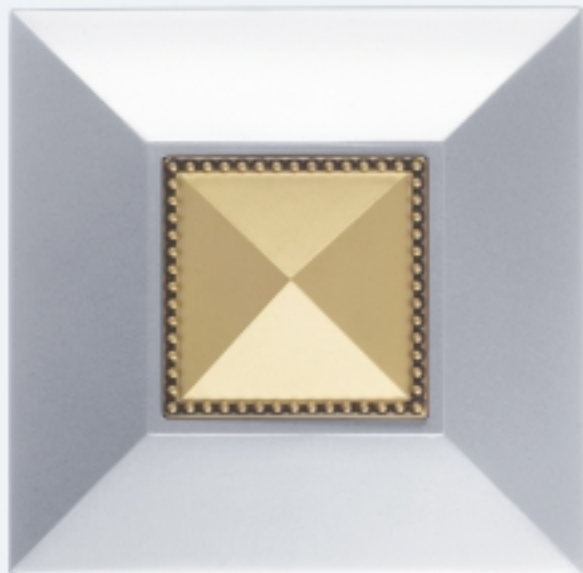

8031 / 1 MV2 AN5

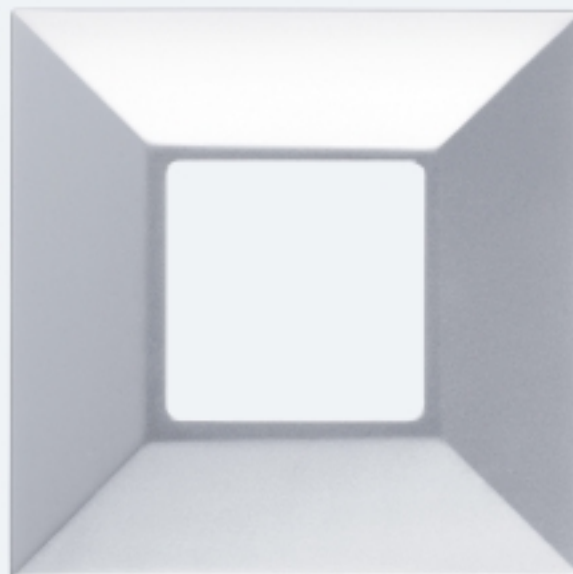

8031 / 2 MV2

0051
0052
8031

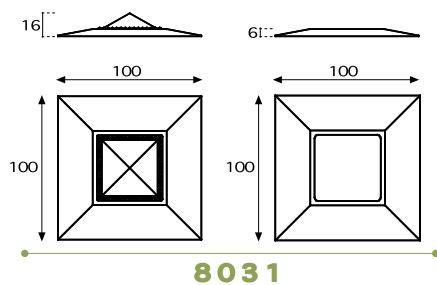

8031

8034 0085
8036 8079



0085/34 MT3



8034/60 MV2



8079/60 MV2

Art.Nr. item no	Farbe colour
0085	unbegrenzte Farbvielfalt endless colour combination
8034	
8036	
8079	



0085

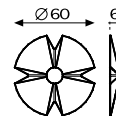

8034

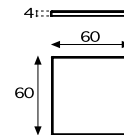

8079



8036/125 CP133M

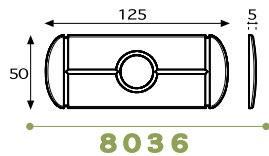

8034
8036
0085
8079

▶ SIRO produziert 4 Kategorien von Profilen... /
SIRO also produces 4 groups of profiles...

1 Bilderrahmenprofil /
picture frame profiles

2 Möbelkanten /
furniture edging profiles



► ...Weitere
detailliertere
Informationen
zu unserem
Profilprogramm
finden Sie bitte
in einem speziellen
Katalog / ...more
information about
the profiles
you will find in
our catalogue



3 Dekoprofile /
decorative profiles

4 Technische Profile /
technical profiles



► die wichtigsten Farben / the most important colours

A
Kunststoff / plastic



MV
Kunststoff - metallic velour/
plastic - metallic velour

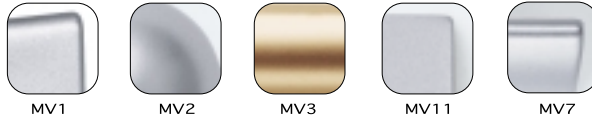

MT
Kunststoff - metallisiert/
plastic - metallized

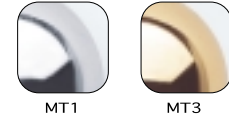

CP
Kunststoff - Holzeffekt/
plastic - wood effect



SN
transparent Effekt/
transparent effect



T
Kunststoff - Gummieffekt
(Soft Touch)/
plastic - rubber effect





unbegrenzte Farbvielfalt / endless colour combination

► wenn Sie größere Farbvielfalt benötigen/
if you want more colours...

...SIRO gibt dir unbegrenzte Farbvielfalt!/
SIRO gives you endless colour combination!

► Artikel Index/ pages index

Art.Nr. item no	seite page
0001	4-5
0003	4-5
0009	6-7
0012	146-147
0021	144-145
0023	44-45
0024	42-43
0028	8-9
0039	76-77
0043	78-79
0050	80-81
0051	152-153
0052	152-153
0061	10-11
0064	82-83
0065	12-13
0066	150-151
0070	84-85
0071	82-83
0076	10-11
0080	80-81
0082	146-147
0083	58-59
0085	154-155
0086	144-145
0087	144-145

Art.Nr. item no	seite page
0088	144-145
0089	86-87
0090	50-51
0091	46-47
0092	48-49
0093	88-89
0094	54-55
0095	52-53
0096	90-91
0097	58-59
0098	156-157
0099	92-93
0287	94-95
0385	14-15
0391	16-17
0416	144-145
0417	144-145
0453	18-19
0549	96-97
0563	98-99
0570	98-99
0592	100-101
0609	20-21
0649	22-23
0719	148-149
0763	148-149

Art.Nr. item no	seite page
0769	24-25
0873	56-57
0927	150-151
8003	102-103
8004	62-63
8006	26-27
8007	104-105
8009	28-29
8010	106-107
8011	108-109
8013	110-111
8014	112-113
8015	30-31
8016	114-115
8017	66-67
8018	116-117
8021	118-119
8022	148-149
8023	156-157
8026	32-33
8027	32-33
8031	152-153
8034	154-155
8036	154-155
8045	60-61
8046	110-111

Art.Nr. item no	seite page
8047	120-121
8054	148-149
8055	156-157
8057	34-35
8059	122-123
8062	12-13
8063	124-125
8064	126-127
8065	128-129
8066	36-37
8067	38-39
8076	64-65
8078	4-5
8079	154-155
8080	130-131
8081	150-151
8085	40-41
8091	132-133
8092	134-135
8094	136-137
8099	68-69
8100	70-71
8103	74-75
8104	72-73
8105	138-139
8106	140-141
SA59	142-143